

NOTE:

- SOLDERTAIL TO BE WITHIN 0.05 UPWARD AND 0.2 DOWNWARD FROM Z-DATUM PLACE, AND COPLANALITY OF SOLDERTAILS TO BE WITHIN 0.10. MEASUREMENT POINT IS SOLDERTAILS TIP.
- CONTACT PLATING: UNDERPLATE 50" NICKEL, CONTACT AREA: GOLD 3 μ"
- INSPECTION SYMBOL:  
 ● : MANUFACTURER INSPECTION  
 ◆ : Q. C INSPECTION

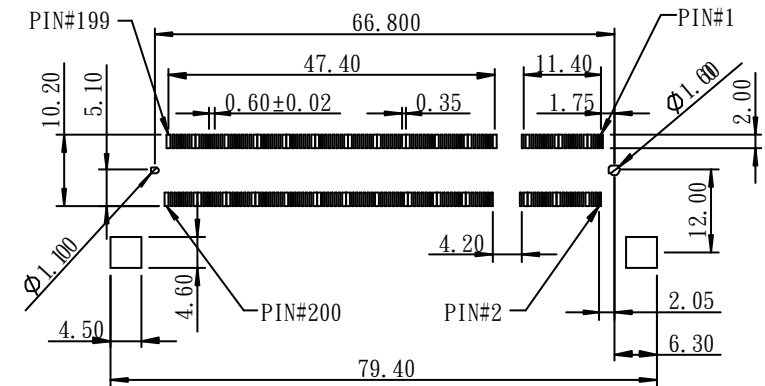
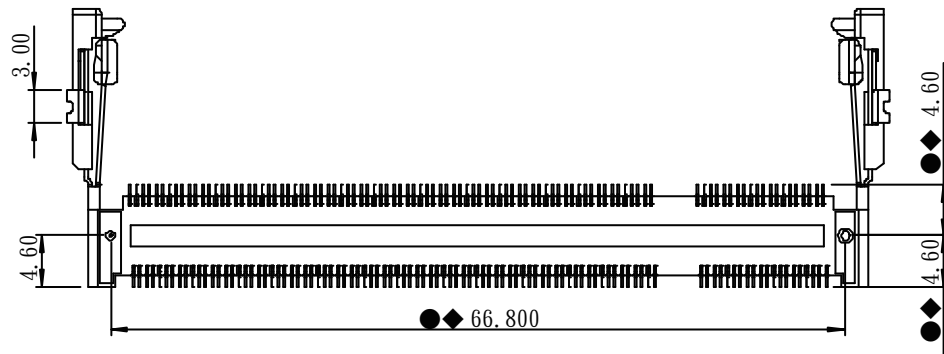
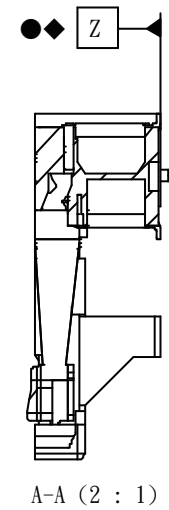
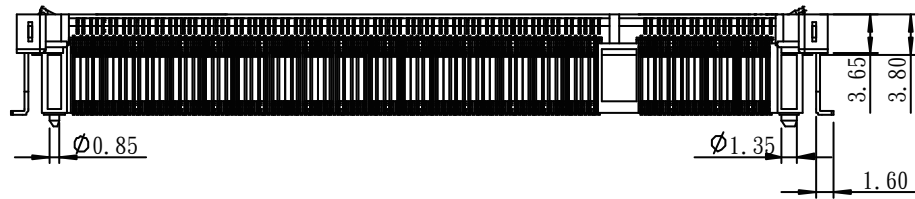

PCB LAYOUT : COMPONENT SIDE

RoHS Compliant

TOLERANCES ARE

**MORETHANALL**  
 PCB CONNECTORS  
 Cable ASSEMBLIES

煜倫股份有限公司

www.morethanall.com

DRAWING BY CY  
 CHECKED BY GENIUS  
 UNIT / mm SCALE 1 : 1  
 DATE  
 SIZE A4 PPROJECTION

X, ±  
 .X ± 0.2  
 .XX ± 0.1  
 .XXX ±  
 ANG ±

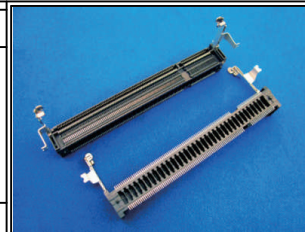

ORDER INFORMATION

**SDM6-W92V18-40A6-LF**  
 SERIES | 1.8V | 40+160 WAY | LEADFREE  
 HIGH: 9.2mm  
 90°SMT

DESCRIPTION: DDR S.O. DIMM 200P ASSEMBLY

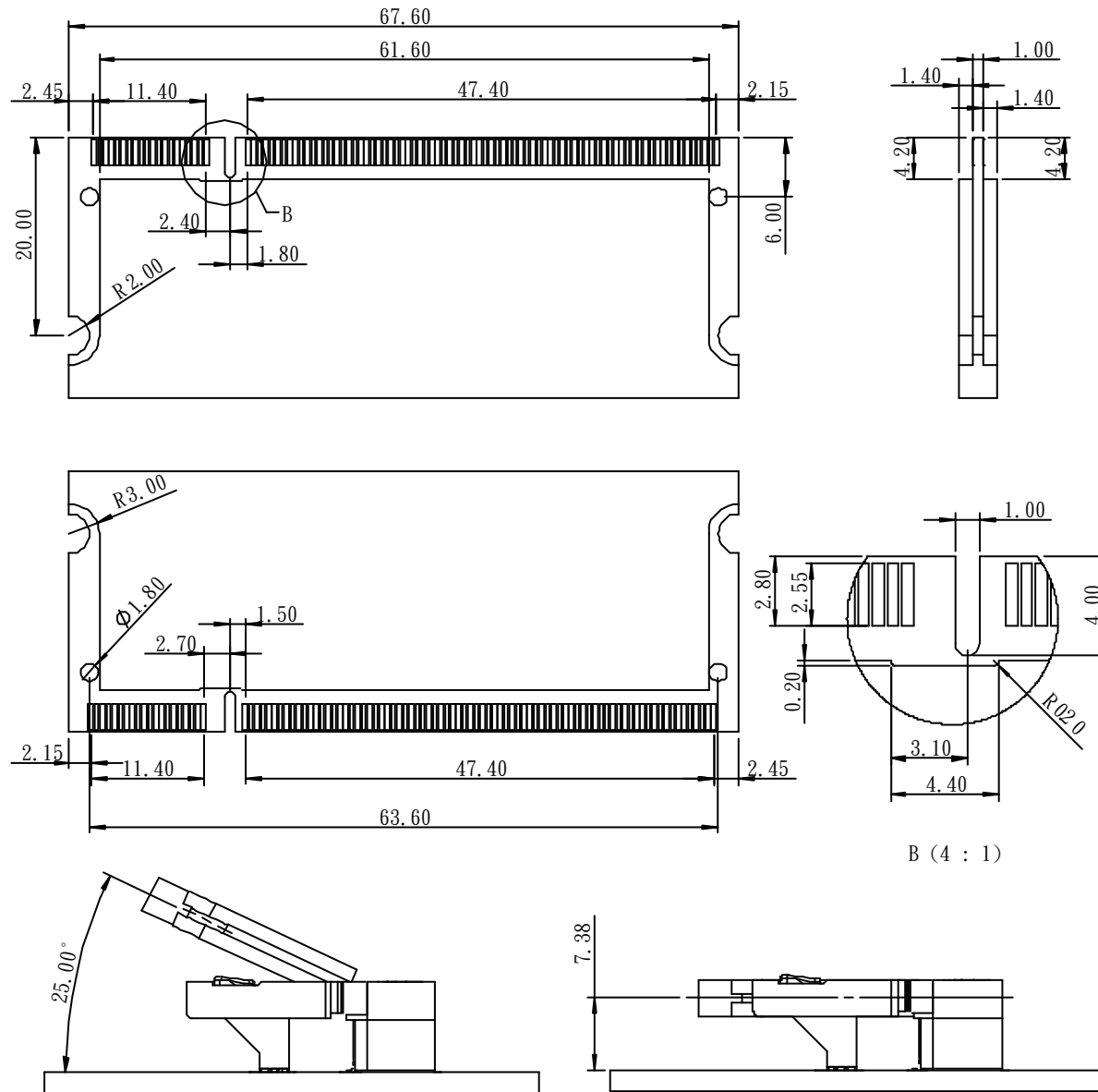

RoHS Compliant

TOLERANCES ARE

**MORETHANALL**  
PCB CONNECTORS  
Cable ASSEMBLIES

DRAWING BY CY

CHECKED BY GENIUS

UNIT / mm SCALE 1 : 1

DATE

SIZE A4

X, ±  
.X ± 0.20  
.XX ± 0.10  
.XXX ±  
ANG ±

PPOJECTION

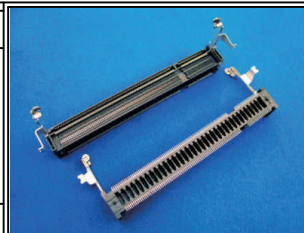

ORDER INFORMATION

SDM6-W92V18-40A6-LF

SERIES | 1.8V | 40+160 WAY | LEADFREE  
HIGH: 9.2mm  
90°SMT

DESCRIPTION: DDR S.O. DIMM 200P ASSEMBLY

煜倫股份有限公司

www.morethanall.com

DDR S.O. DIMM 200P 5.2&9.2 OVERLAY FIGURE

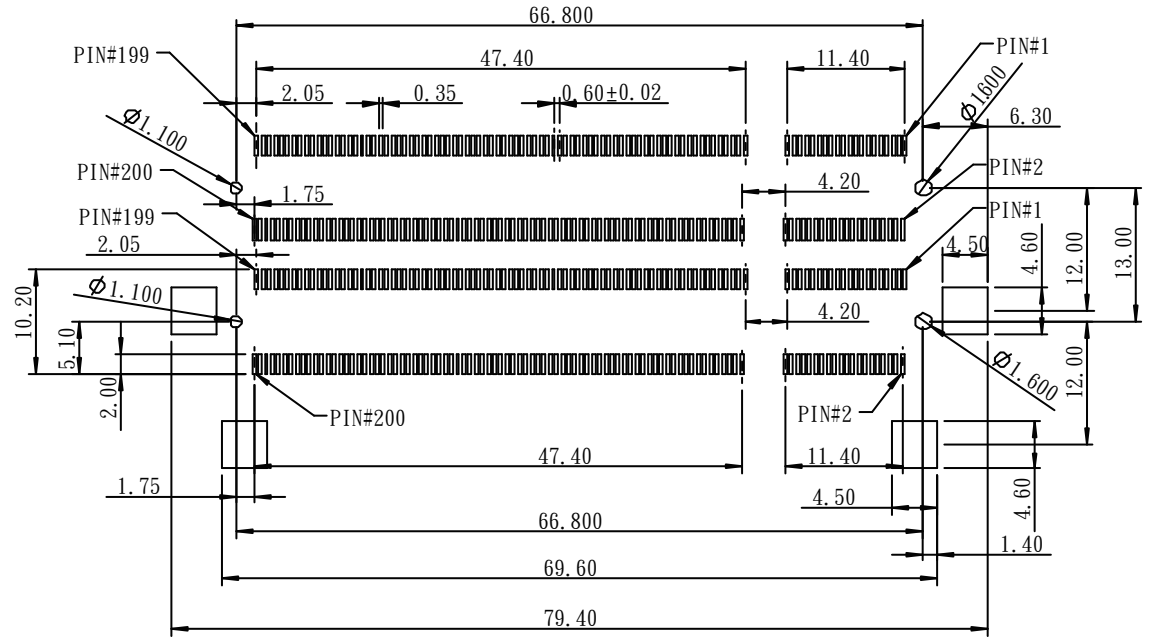
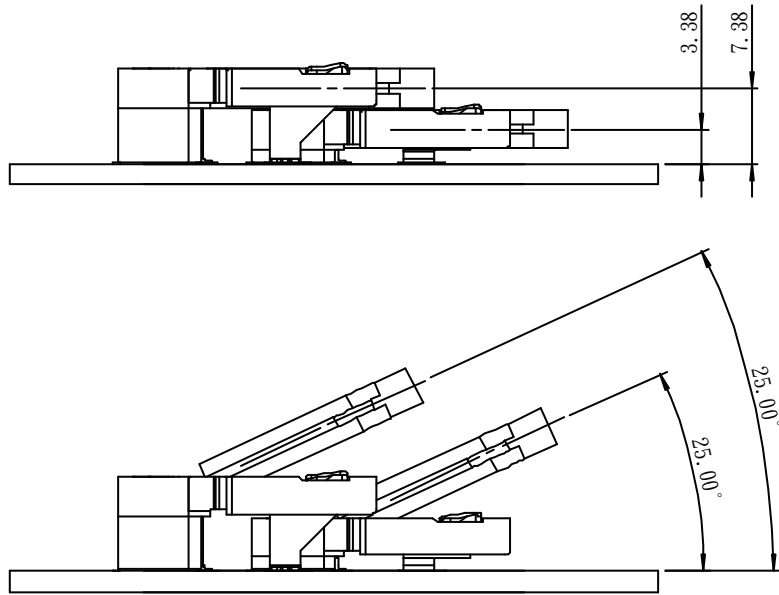

PCB LAYOUT : COMPONENT SIDE(5.2&9.2TYPE)

RoHS Compliant

TOLERANCES ARE

**MORETHANALL**  
PCB CONNECTORS  
Cable ASSEMBLIES

DRAWING BY CY

X, ±

CHECKED BY GENIUS

.X ± 0.20

UNIT / mm

SCALE 1:1

.XX ± 0.10

DATE

.XXX ±

ANG ±

SIZE A4

PPOJECTION

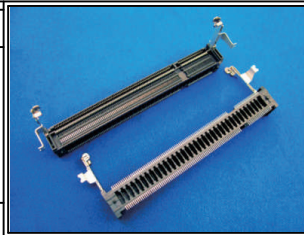

ORDER INFORMATION

**SDM6-W92V18-40A6-LF**  
SERIES | 1.8V | 40+160 WAY | LEADFREE  
HIGH:9.2mm  
90°SMT

煜倫股份有限公司

www.morethanall.com

DESCRIPTION: DDR S.O. DIMM 200P ASSEMBLY

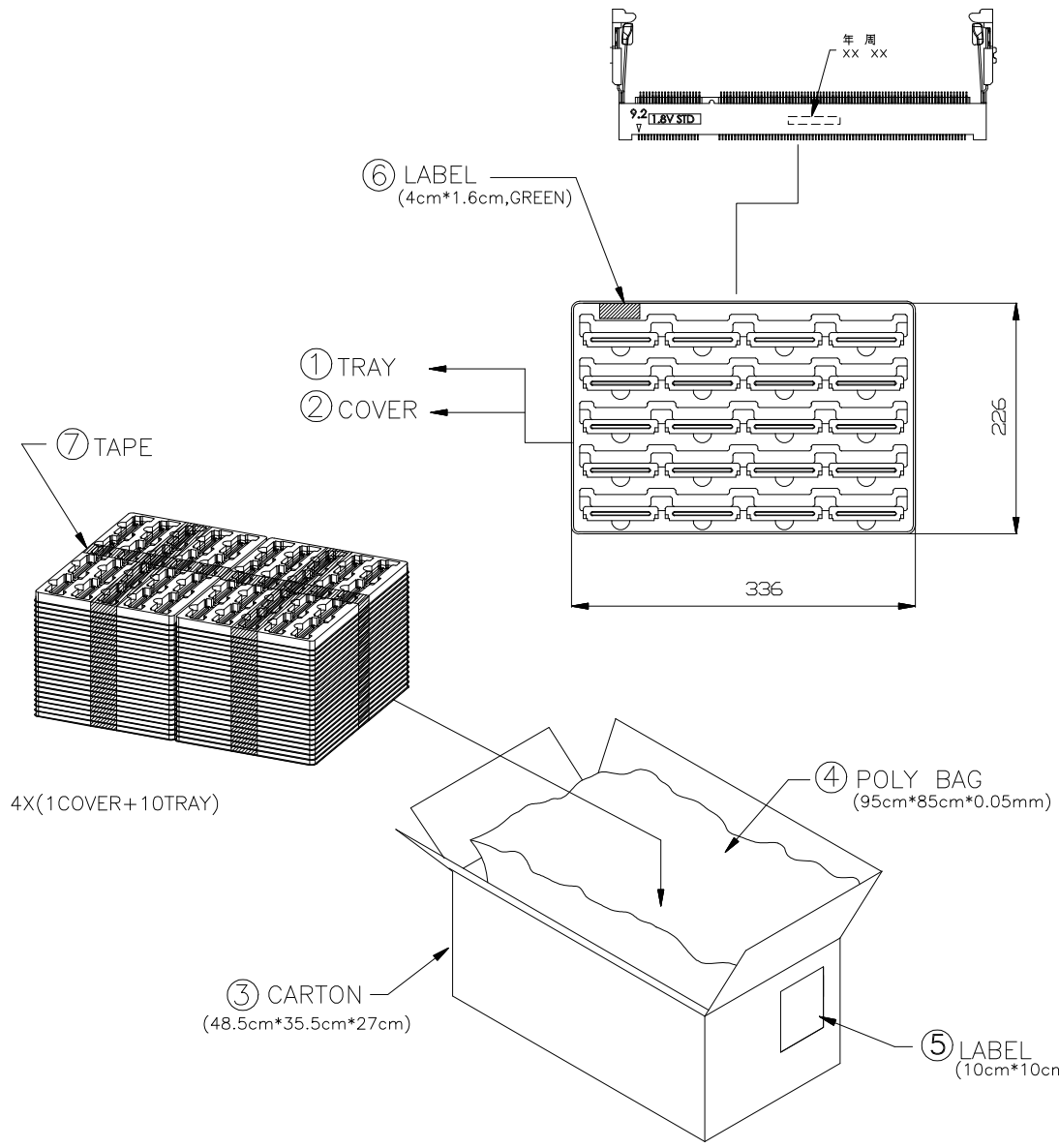

	MATERIAL	P/N	REMARKS
1	TRAY	TRAY 070-004B	36 TRAY X 20PCS
2	COVER	TRAY 070-004B	4X(1COVER+9TRAY)
3	CARTON	CTN-C100D	CARTON/36 TRAYS/720PCS
4	POLY BAG	P-0001	1 POLY BAG/CARTON
5	LABEL(for RoHS)	CTP-00002	1 LABEL/CARTON
6	LABEL(for RoHS)	CTB-00002	1 LABEL/TRAY
7	TAPE		

**RoHS Compliant**

TOLERANCES ARE

**MORETHANALL**  
PCB CONNECTORS  
Cable ASSEMBLIES

DRAWING BY CY

X, ±

CHECKED BY GENIUS

.X ± 0.20

UNIT/mm

SCALE 1:1

.XX ± 0.10

DATE

.XXX ±

ANG ±

SIZE A4

PPOJECTION

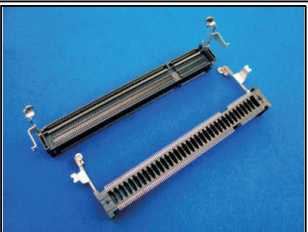

**ORDER INFORMATION**

**SDM6-W92V18-40A6-LF**

SERIES | 1.8V | 40+160 WAY | LEADFREE  
HIGH:9.2mm  
90°SMT

**煜倫股份有限公司**

[www.morethanall.com](http://www.morethanall.com)

DESCRIPTION: PACKING INFORMATION