

Recommend P.C.B Layout

備註 /NOTE

1. 安規 /SAFETY :
 - 1-1. 規格 /RATING : 100V AC MAX OR 12V DC 2A MAX
 - 1-2. 絕緣阻抗 /INSULATION RESISTANCE : 100M MIN AT 500 DC
 - 1-3. 絕緣耐壓 /DIELECTRIC WITHSTANDING VOLTAGE : 1000V AC AT 1 MINUTE
2. 材質 /MATERIAL :
 - 2-1. 鐵殼 /SHELL : 不銹鋼 /STAINLESS
 - 2-2. 膠芯 /HOUSING : LCP
 - 2-3. 端子 /PIN : 磷銅 /PHOSPHOR BRONZE
3. 電鍍 /PLATING :
 - 3-1. 端子 /PIN : 鍍金 10u"/TIN, GOLD 10u"

RoHS Compliant

TOLERANCES ARE

MORETHANALL
PCB CONNECTORS
Cable ASSEMBLIES

煜倫股份有限公司

www.morethanall.com

DRAWING BY CY

CHECKED BY GENIUS

UNIT / mm

SCALE 1 : 1

DATE

SIZE A4

P PROJECTION

X, ±
.X ±
.XX ±
.XXX ±
ANG ±

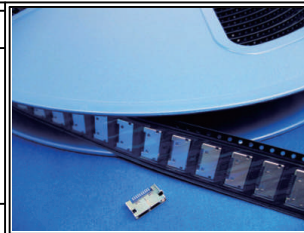

ORDER INFORMATION

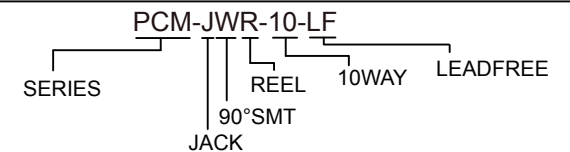

DESCRIPTION: PCMCIA 10PIN 母座成品

步驟一:

1. 將成品一一放入包裝盤內,依同一方向置入.
2. 包裝方式,如圖所示.
3. 一個包裝盤內放1000pcs.

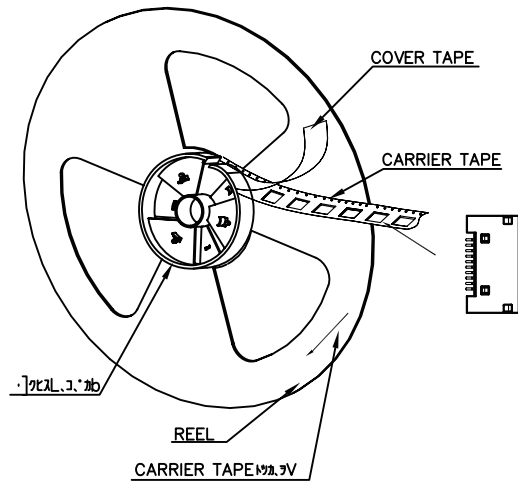

步驟二:

1. 一個紙箱可以裝10個包裝盤.
2. 每盤1000pcs,每箱10000pcs.
3. 將包裝盤放入防水袋中,包裝完後再封箱.

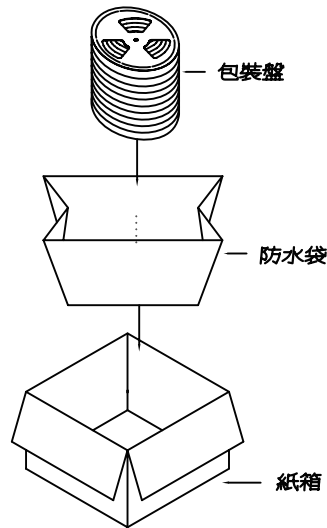

步驟三:

1. 用膠帶將紙箱封實.
2. 將標籤貼於紙箱上.

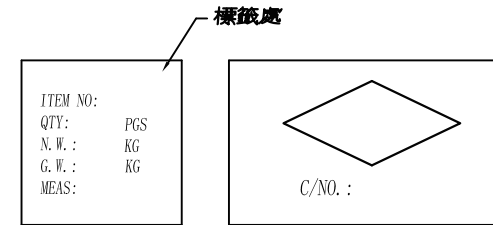

NOTE:

1. 若有未裝滿之零數箱,必須以緩衝材塞滿.
2. 在搬運過程中要輕拿輕放.
3. 載運輸中不可堆放過多,不可有重壓現象.
4. 在裝滿產品後,必須空留帶前和帶後15格以上,然後用紙膠布貼上.
5. 上帶在貼下帶時必須平整,且黏貼處不要出現氣泡.

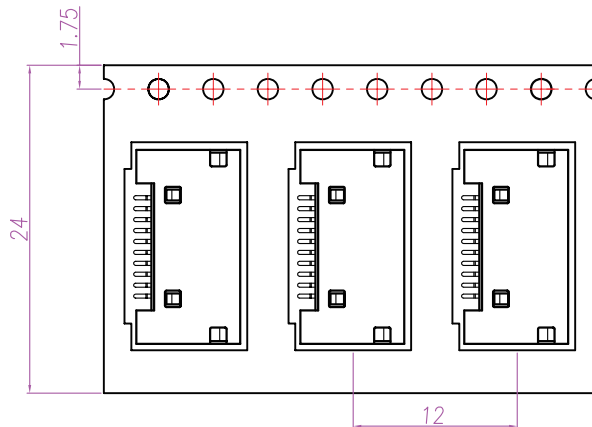

RoHS Compliant

TOLERANCES ARE

MORETHANALL
PCB CONNECTORS
Cable ASSEMBLIES

煜倫股份有限公司

www.morethanall.com

DRAWING BY CY

CHECKED BY GENIUS

UNIT/mm SCALE 1:1

DATE

SIZE A4

X. ±
.X ±
.XX ±
.XXX ±
ANG ±

PJECTION

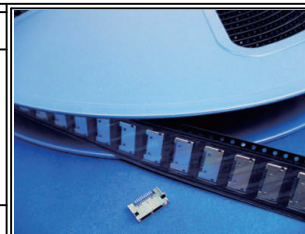

ORDER INFORMATION

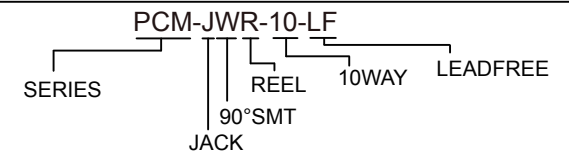

DESCRIPTION: