

NOTES:

- MATERIAL:**
HOUSING: HIGH TEMPERATURE THERMO PLASTIC UL94V-0
TERMINAL: COPPER ALLOY
SOLDER PEG: COPPER ALLOY
- FINISH:**
TERMINAL:
CONTACT AREA: SEE CHARTS
SOLDERING AREA: SEE CHARTS
UNDER PL.: NICKEL PL. 50 μ" THK MIN.
- THIS PRODUCT DOESN'T CONTAIN ENVIRONMENTAL HAZARDOUS PER DIRECTIVE 2002/95/EC FOR RoHS COMPLIANT.**

RoHS Compliant

TOLERANCES ARE

MORETHANALL
PCB CONNECTORS
Cable ASSEMBLIES

煜倫股份有限公司

www.morethanall.com

DRAWING BY CY

CHECKED BY GENIUS

UNIT / mm SCALE 1:1

DATE

SIZE A4

X, ±
.X ±
.XX ±
.XXX ±
ANG ±

PJECTION

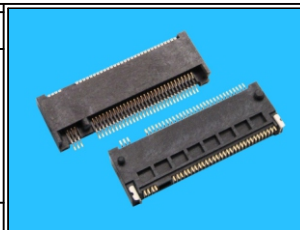

ORDER INFORMATION

NGFF-W32-0760-LF

SERIES | LEADFREE
07+60 WAY
HIGH 3.2mm
90°SMT

DESCRIPTION:

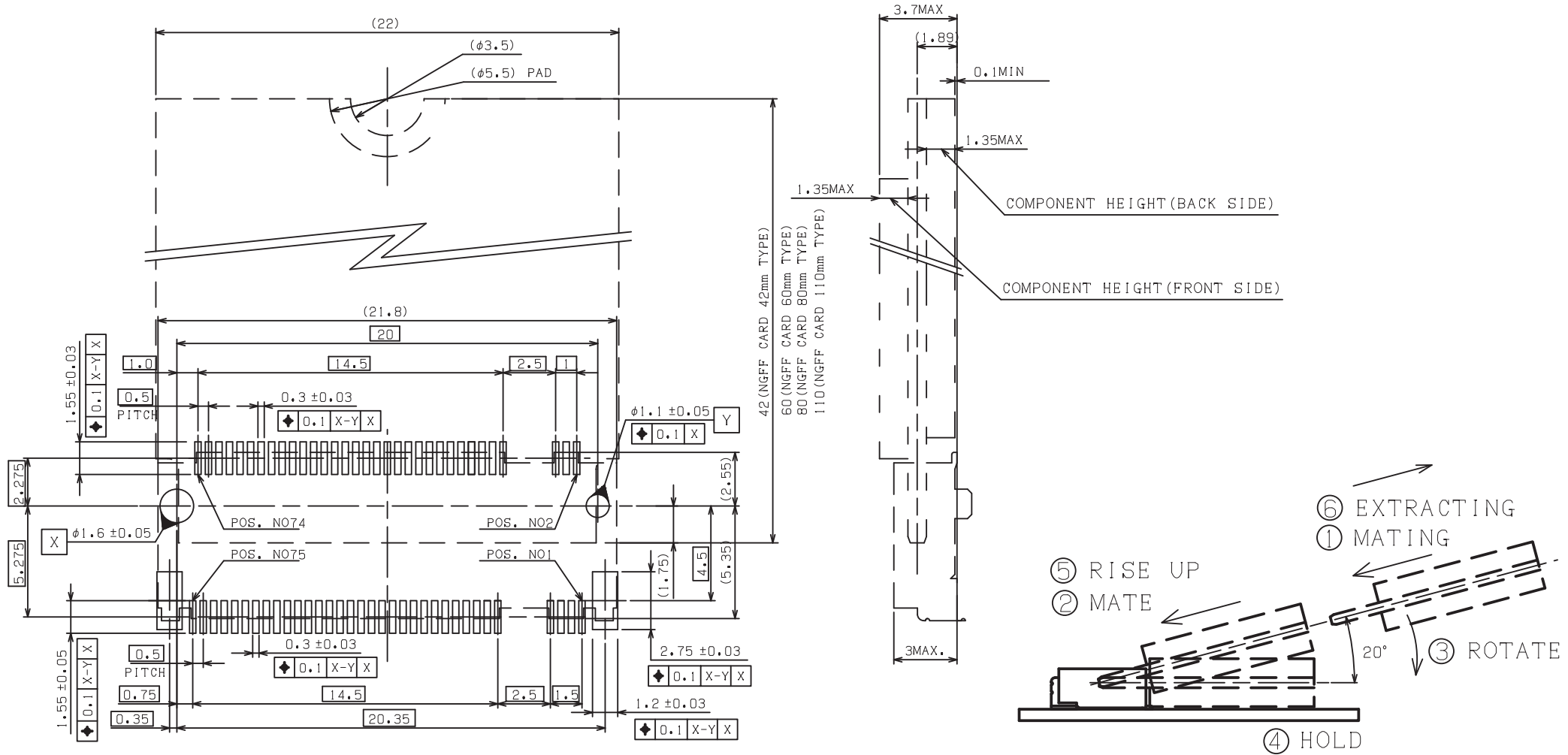

KEY ID "A"
RECOMMENDED P.C. BOARD LAYOUT

RoHS Compliant

TOLERANCES ARE

MORETHANALL
PCB CONNECTORS
Cable ASSEMBLIES

DRAWING BY CY
CHECKED BY GENIUS
UNIT / mm SCALE 1:1
DATE
SIZE A4

X. ±
.X ±
.XX ±
.XXX ±
ANG ±

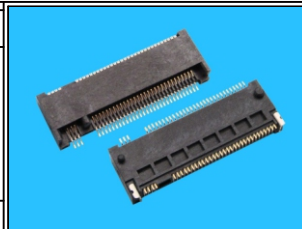

ORDER INFORMATION

NGFF-W32-0760-LF
SERIES | LEADFREE
07+60 WAY
HIGH 3.2mm
90°SMT

煜倫股份有限公司

www.morethanall.com

PJECTION

DESCRIPTION:

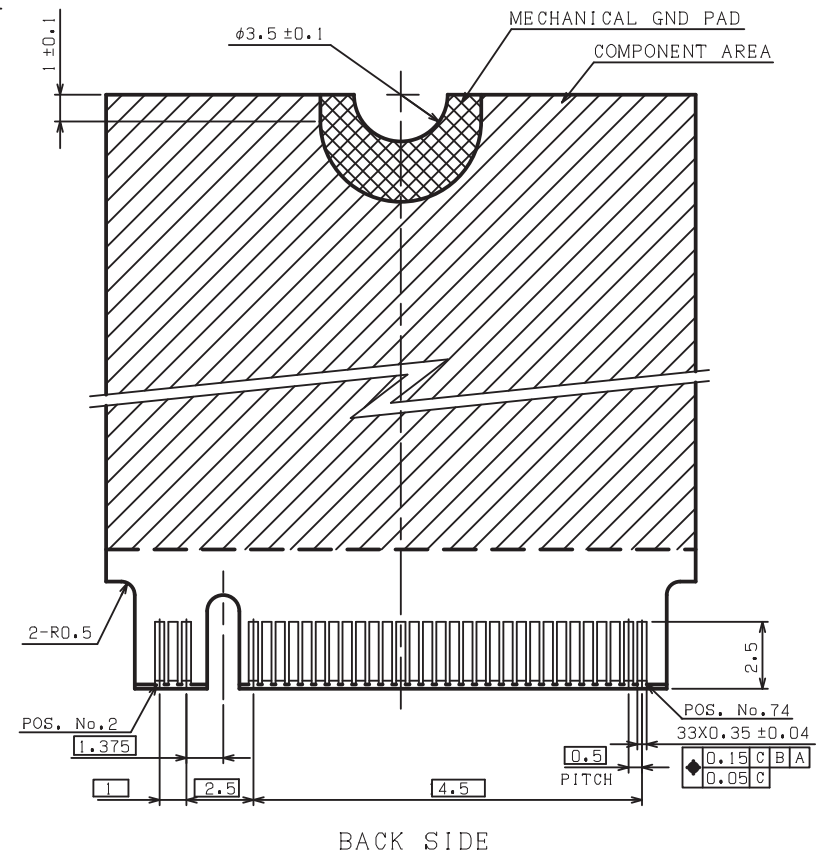
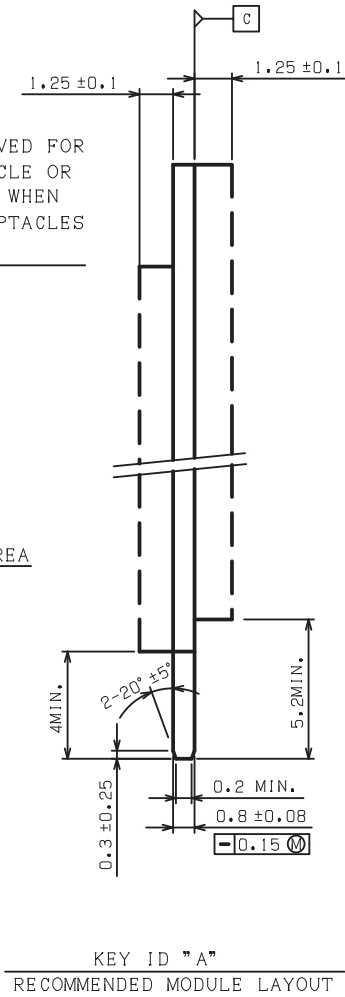
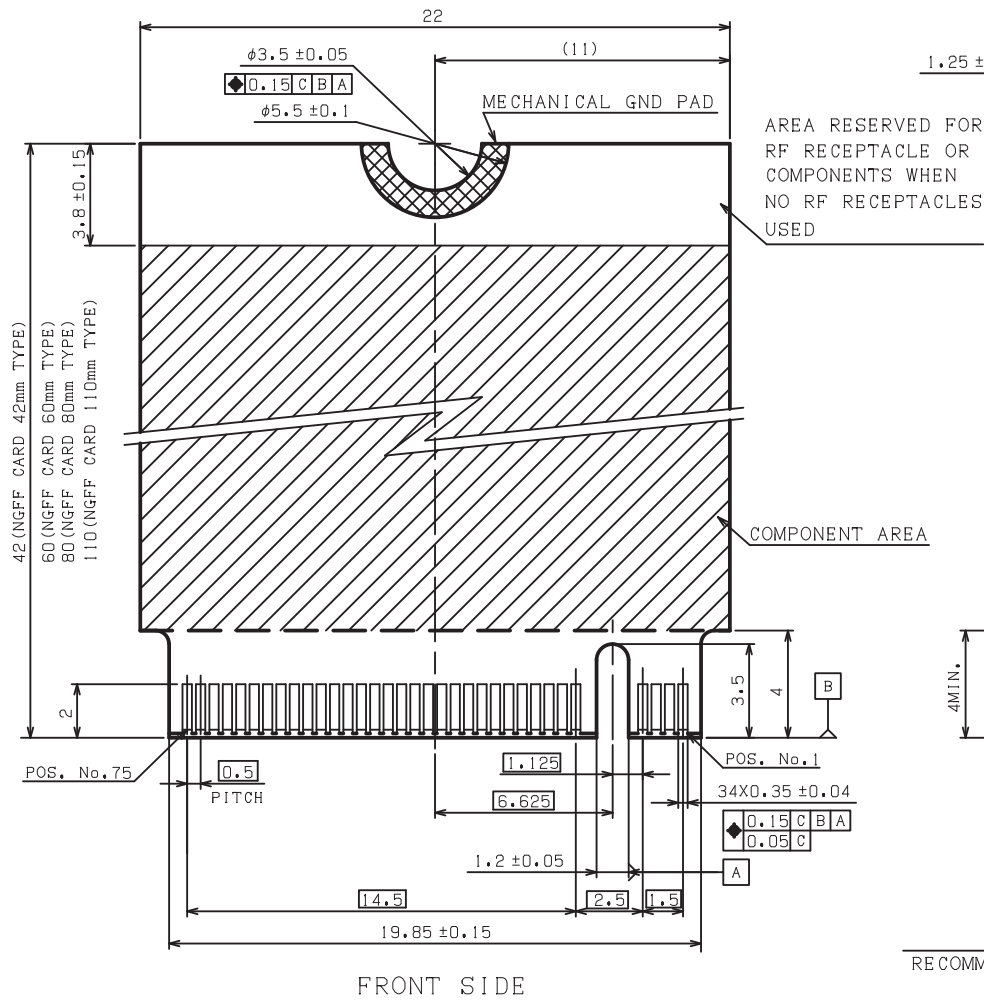

MORETHANALL
PCB CONNECTORS
Cable ASSEMBLIES
煜倫股份有限公司
www.morethanall.com

RoHS Compliant

DRAWING BY CY
CHECKED BY GENIUS
UNIT / mm SCALE 1 : 1
DATE
SIZE A4 PPROJECTION

TOLERANCES ARE

X. ±
.X ±
.XX ±
.XXX ±
ANG ±

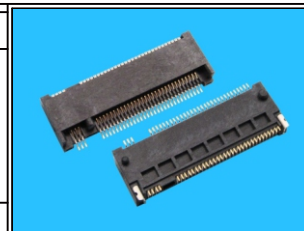

ORDER INFORMATION

NGFF-W32-0760-LF
SERIES | LEADFREE
| 07+60 WAY
HIGH 3.2mm
90°SMT

DESCRIPTION: