

Section:A-A

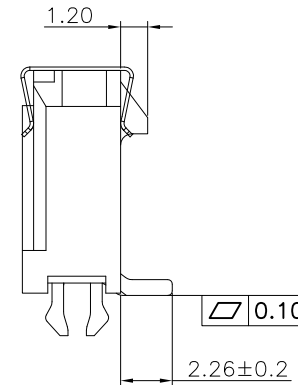
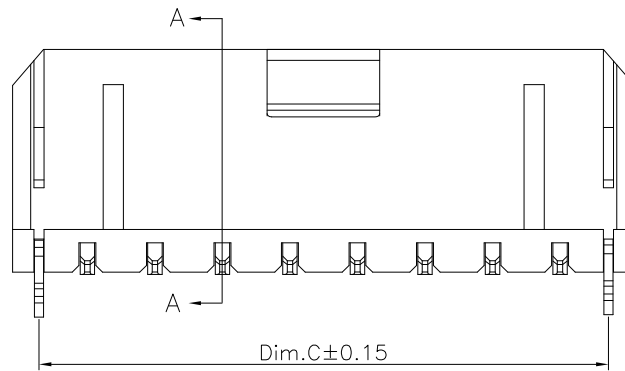

Specifications:
 △ Current rating:1.0~7.0Amps
 Voltage rating:250V AC,DC
 Contact resistance:10mohm Max
 Insulation resistance:1,000Mohm min.
 Withstanding voltage:1,500V AC;DC
 Operating Temperature range:-40°C ~ +105°C

Materials:
 Insulator:High Temp.Plastic(LCP UL94V-0)
 Color:Black
 Terminal:Copper Alloy
 Plating:Tin Plated

Positions	Dimension			Positions	Dimension		
	A	B	C		A	B	C
2	9.65	3.00	7.30	8	27.65	21.00	25.30
3	12.65	6.00	10.30	9	30.65	24.00	28.30
4	15.65	9.00	13.30	10	33.65	27.00	31.30
5	18.65	12.00	16.30	11	36.65	30.00	34.30
6	21.65	15.00	19.30	12	39.65	33.00	37.30
7	24.65	18.00	22.30				

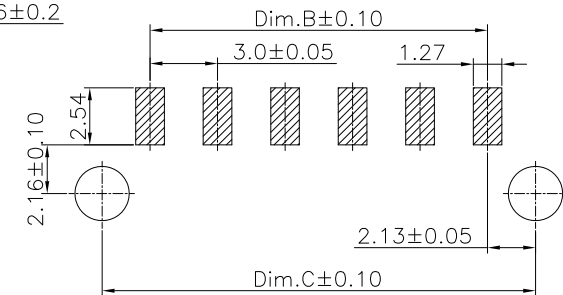

PCB LAYOUT

RoHS Compliant

TOLERANCES ARE

MORETHANALL
 PCB CONNECTORS
 Cable ASSEMBLIES

DRAWING BY CY

X.±

CHECKED BY GENIUS

.X±0.20

UNIT / mm

SCALE 1 : 1

.XX±0.15

DATE

.XXX±

ANG±

SIZE A4

PJECTION

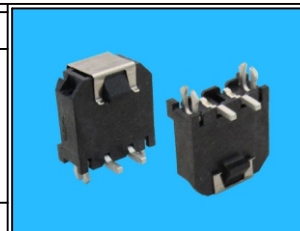

ORDER INFORMATION

MIF-PVZC-1Xxx-LF
 SERIES | MALE | CAP CLIP | LEADFREE
 1X02:02WAY
 1X12:12WAY
 180°SMT

煜倫股份有限公司

www.morethanall.com

DESCRIPTION: 3.0mm Wafer Single Row SMD Type

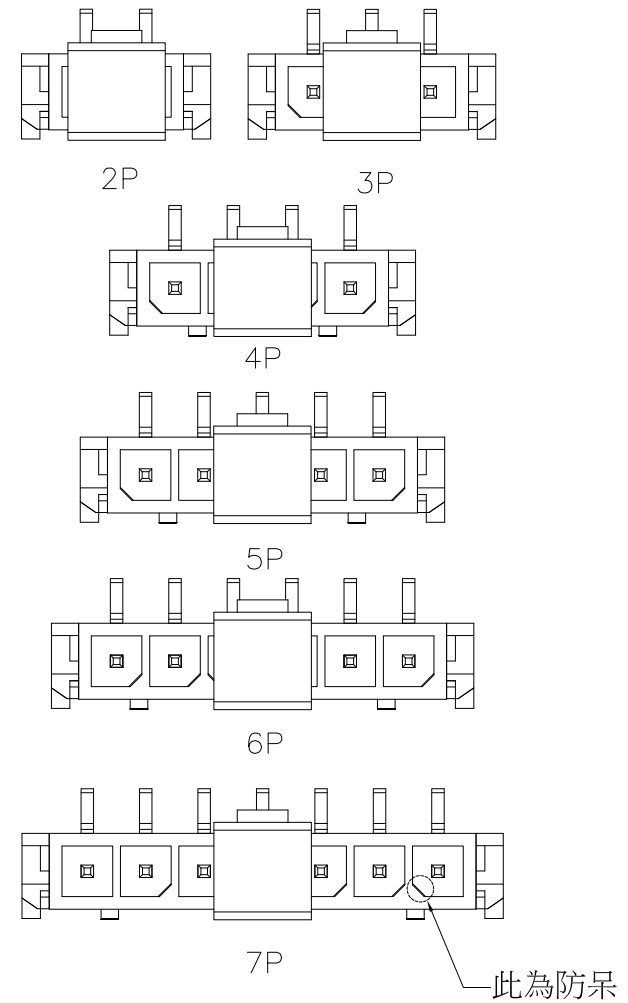
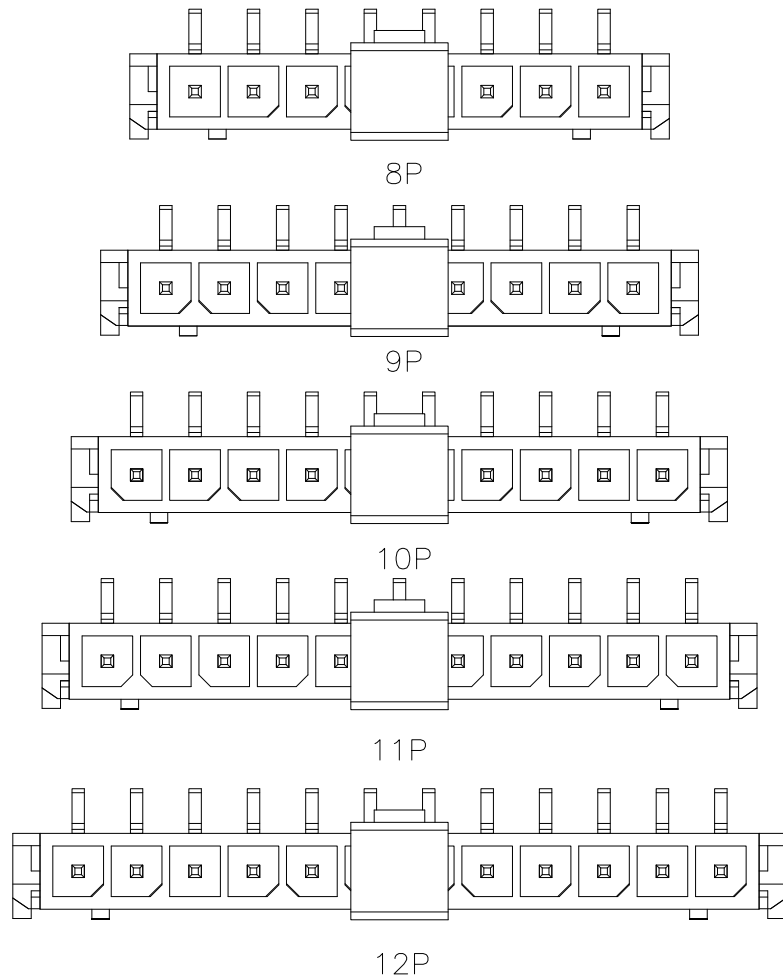

(2-12)Pin防呆位置分部示意圖

RoHS Compliant

TOLERANCES ARE

MORETHANALL
PCB CONNECTORS
Cable ASSEMBLIES

DRAWING BY CY

X, ±

CHECKED BY GENIUS

.X ± 0.20

UNIT / mm

SCALE 1 : 1

.XX ± 0.15

DATE

.XXX ±

ANG ±

SIZE A4

PPOJECTION

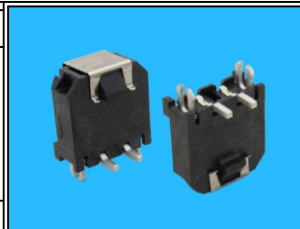

ORDER INFORMATION

MIF-PVZC-1Xxx-LF

SERIES

MALE

CAP

CLIP

180°SMT

LEADFREE

1X02:02WAY

1X12:12WAY

煜倫股份有限公司

www.morethanall.com

DESCRIPTION: 3.0mm Wafer Single Row SMD Type