

Date code:
 YY WW D
 D=Weekday
 ordinate (1-7)where
 "1"=Sunday
 WW=Week
 YY=Year

SPECIFICATION
MATERIAL
 Insulator: LCP E6808, rated UL94V-0
 Contacts: Copper Alloy
CONTACT PLATING
 Underplate: 50u"~120u" Nickel Δ
 Contact area: 1u" Gold ~ 8u" Selective gold
ELECTRICAL
 Current rating:
 Δ Contact: 2.0A
 Ground Plane: 7.8A
 Operating Temp Range:
 -55°C to + 125°C
 Voltage Rating:
 Δ 225VAC(5mm Stack Height)
 Δ Withstanding voltage: 675VAC
 Mating cycles: 100 insertions

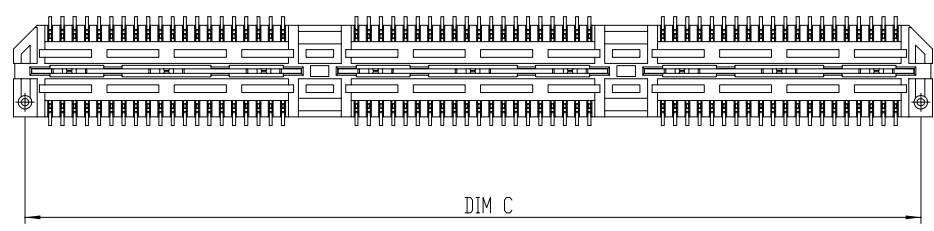
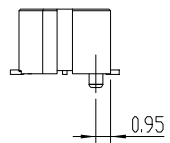

	40 PIN	80 PIN	120 PIN
DIM A	20.00	40.00	60.00
DIM B	16.90	36.90	56.90
DIM C	18.48	38.48	58.48

RoHS Compliant

TOLERANCES ARE



煜倫股份有限公司

www.morethanall.com

DRAWING BY CY

CHECKED BY GENIUS

UNIT / mm SCALE 1 : 1

DATE

SIZE A4

X. ± 0.30
 .X ± 0.20
 .XX ± 0.12
 .XXX ±
 ANG ± 5°

PJECTION

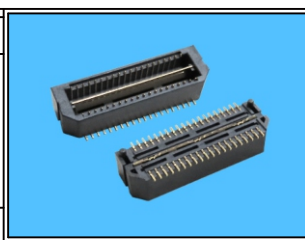

ORDER INFORMATION

HSNP0859-P040P-xxx-LF

SERIES | LEADFREE
 | 040.080.120WAY
 | POST
 | UNMATED HIGH 4.0mm
 MALE

DESCRIPTION: HI-SPEED GROUND PLANE HEADER PITCH=0.80mm, 4.27mm High, 20PINS/BANK

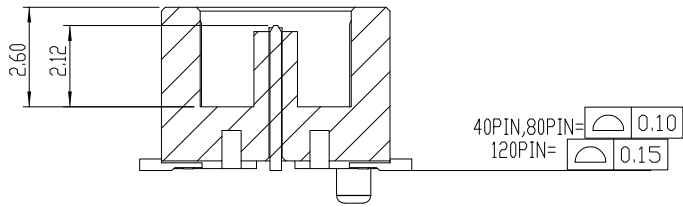

剖面圖 A-A

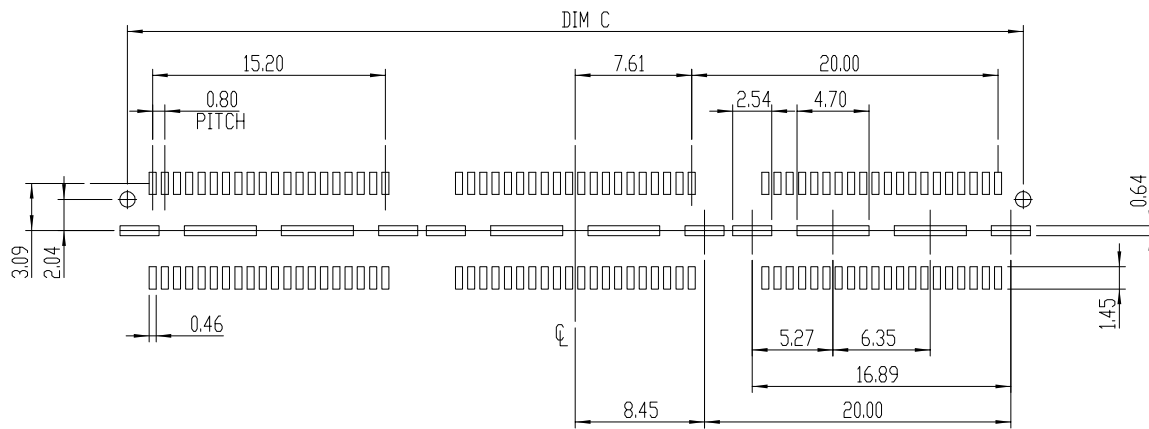

RECOMMEND PCB LAYOUT
TOLERANCES± 0.03

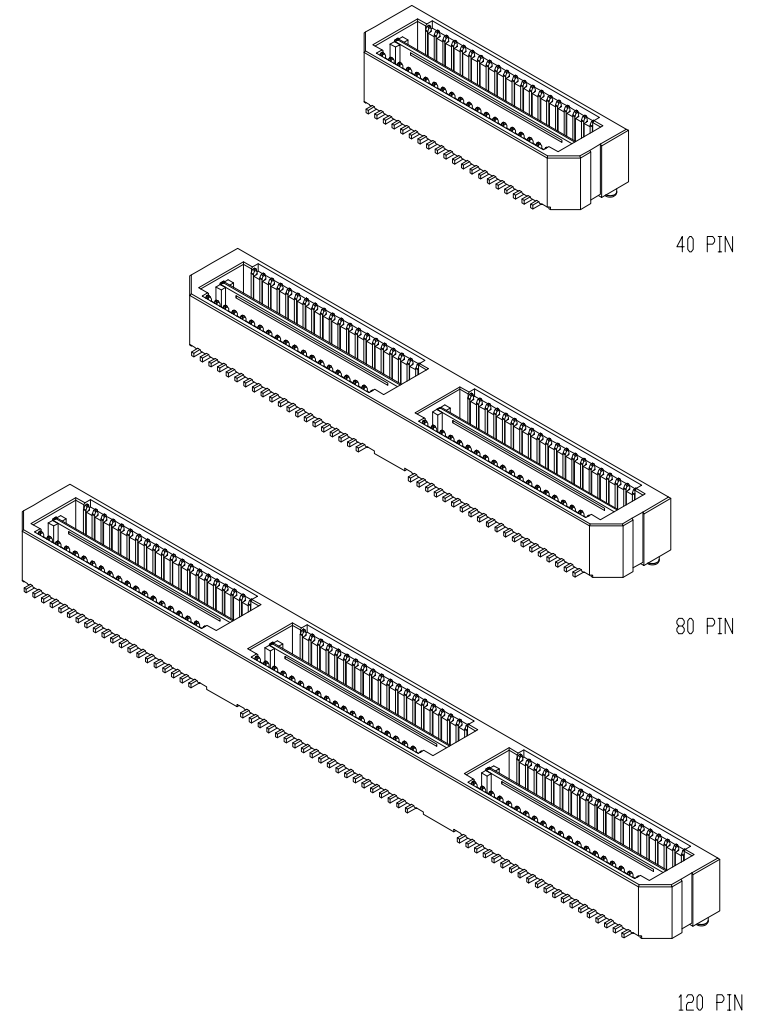

RoHS Compliant

TOLERANCES ARE

MORETHANALL
PCB CONNECTORS
Cable ASSEMBLIES

DRAWING BY CY

X ± 0.30

CHECKED BY GENIUS

.X ± 0.20

UNIT / mm

SCALE 1 : 1

.XX ± 0.12

DATE

.XXX ±

ANG ± 5°

SIZE A4

PJECTION

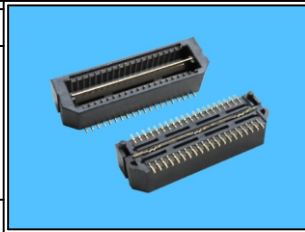

ORDER INFORMATION

HSNP0859-P040P-xxx-LF

SERIES

LEADFREE

040.080.120WAY

POST

UNMATED HIGH 4.0mm

MALE

煜倫股份有限公司

www.morethanall.com

DESCRIPTION: HI-SPEED GROUND PLANE HEADER PITCH=0.80mm, 4.27mm High, 20PINS/BANK