

RECOMMENDED PCB LAYOUT
TOP VIEW
PCB THICKNESS: 1.60±0.05mm
TOLERANCE: ±0.05mm

Electrical Characteristics :
 Insulation Resistance : 500MΩ Min.
 Contact Resistance : 50mΩ Max.
 Withstand Voltage : 1000 VAC 1 minute.
 Current Rating : 1.5A

Material:
 Housing: High-Thermoplastic UL94V-0
 Contact : Selective Gold Plating
 Terminal: 0.25mm Thickness Copper Alloy
 Plated With Gold And Tin In Solder Area.
 Shell: Alloy ,Nickel Plating

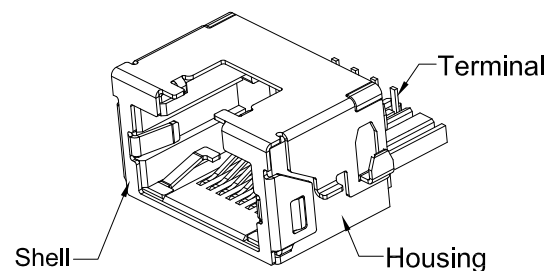

RoHS Compliant

TOLERANCES ARE

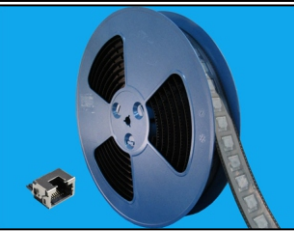

ORDER INFORMATION

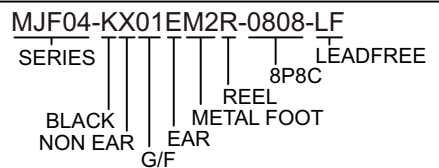

MORETHANALL
 PCB CONNECTORS
 Cable ASSEMBLIES

DRAWING BY CY		X. ± .X ± 0.25 .XX ± 0.15 .XXX ± 0.075 ANG ±
CHECKED BY GENIUS		
UNIT / mm	SCALE 1 : 1	
DATE		
SIZE A4	PPOJECTION	

煜倫股份有限公司

www.morethanall.com

DESCRIPTION: RJ45,Shielded,Receptacle, Horizontal,Single Port,Tht

1.

包材: 卷料式包裝帶 1 SET
 流程單編號標籤 1 PC
 無鉛製程標籤  1 PC
 數量: 1*250=250 PCS
 PACKING MATERIAL: PS TAPE REEL 1 SET
 Q' TY: 1*250=250 PCS

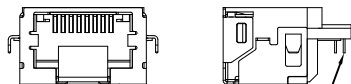

端子腳朝下放置

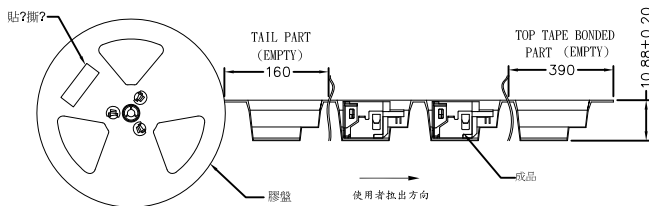
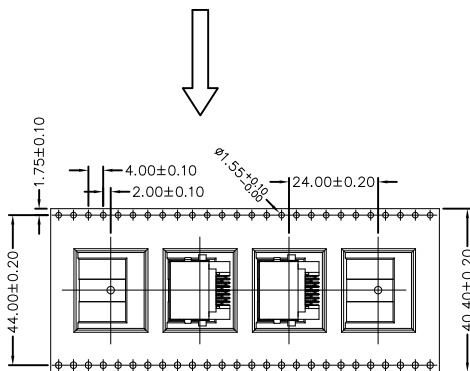

2.

包材: 外箱 1 PC
 無鉛製程標籤  1PC
 平卡/紙板 2PC
 護角板 2PC
 數量: \triangle 250*6=1500 PCS
 PACKING MATERIAL: CARTON 1 PC
 Q' TY: 250*6=1500 PCS

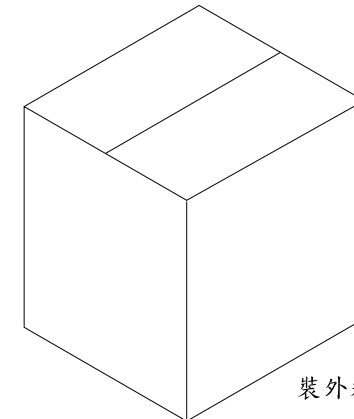
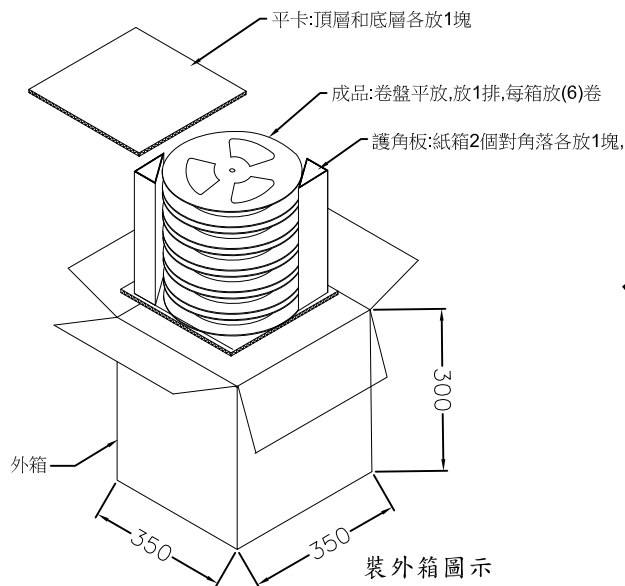

裝外箱OK

淨毛重
 單位(KG)
 數量
 單位(PCS)

P/N	N.W.	G.W.	Q'TY 
MJF04-KX01EM2R-0808	2.95Kg	6.30±0.3Kg	1500

RoHS Compliant

TOLERANCES ARE

MORETHANALL
 PCB CONNECTORS
 Cable ASSEMBLIES
煜倫股份有限公司

DRAWING BY CY

CHECKED BY GENIUS

UNIT / mm
 DATE

SCALE 1 : 1

SIZE A4

PJECTION 

X, ±
 .X ± 0.25
 .XX ± 0.15
 .XXX ± 0.075
 ANG ±

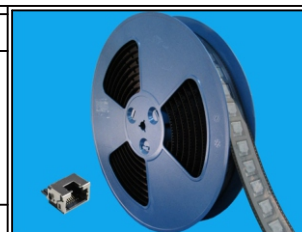

ORDER INFORMATION

MJF04-KX01EM2R-0808-LF

SERIES | REEL | LEADFREE
 BLACK | METAL FOOT
 NON EAR | EAR
 G/F

DESCRIPTION: RJ45,Shielded,Receptacle, Horizontal,Single Port,Tht

www.morethanall.com