

P.C.B LAYOUT MOUNTING PATTERN

NOTES:

MATERIAL:

- 1.1 Housing: LCP
- 1.2 Contact: PHOSPHOR BRONZE
- 1.3 Shell: SUS

Finish:

- 2.1 Contact: Plated Gold in Mating Area ;
Gold Plated on Solder Balls ;
Nickel under plated overall
- 2.2 Shell: Nickel under Plated surface layer

3.SPECIFICATION:

- 3.1 CURRENT RATING: 1.0A MAX
- 3.2 DIELECTRIC WITHSTANDING VOLTAGE: 100 V(ac) FOR 1min
- 3.3 CONTACT RESISTANCE: 30 mΩ MAX.
- 3.4 INSULATION RESISTANCE: 100 MΩ MIN.
- 3.5 TOTAL MATING FORCE: 3.57 Kgf MAX.
- 3.6 TOTAL UNMATING FORCE: 1.0 Kgf MIN.
- 3.7 TEMPERATURE RANGE: -30°C ~ +80°C

RoHS Compliant

TOLERANCES ARE

MORETHANALL
PCB CONNECTORS
Cable ASSEMBLIES

DRAWING BY CY

CHECKED BY GENIUS

UNIT / mm

SCALE 1 : 1

DATE

SIZE A4

PPOJECTION

Up to 5 ±0.2
Above 5 ~ 15 ±0.3
Above 15 ~ 30 ±0.4
Above 30 ~ 50 ±0.5
Angle ±0.3°

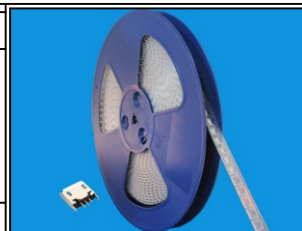

ORDER INFORMATION

MISB-SDM2R-5AB-LF
SERIES | LEADFREE
5 PIN AB TYPE
REEL
METAL FOOT
DIP 180°
FEMALE

DESCRIPTION: MICRO USB 5PF ABTYPE 直立式 捲邊 腳長 1.5mm

煜倫股份有限公司

www.morethanall.com

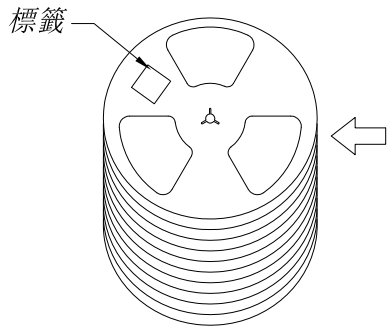

10盤 ↓

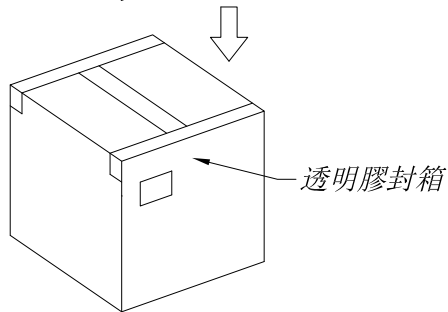
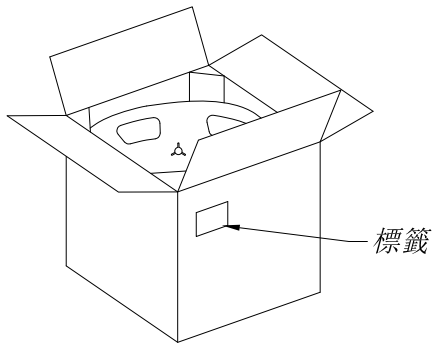

10K/箱 紙箱規格: 360*360*220mm

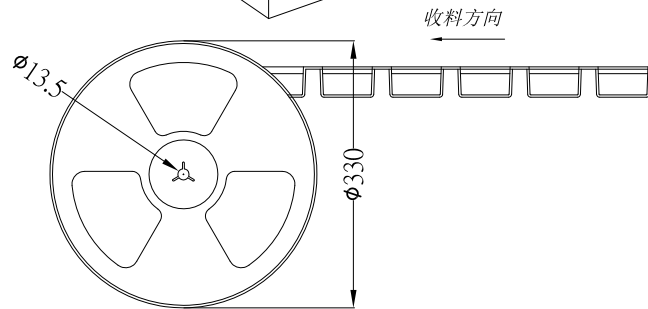
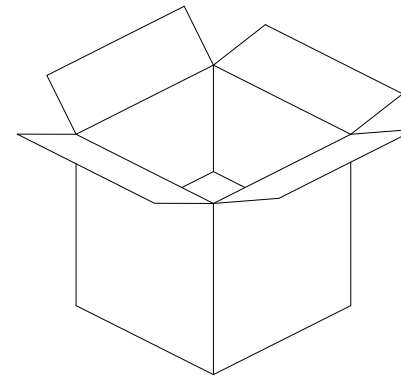
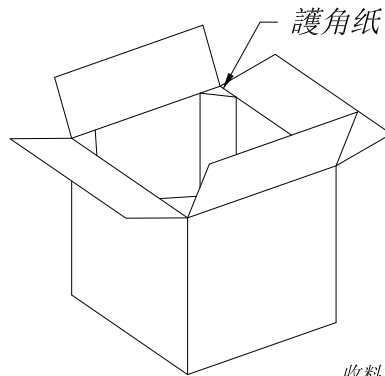
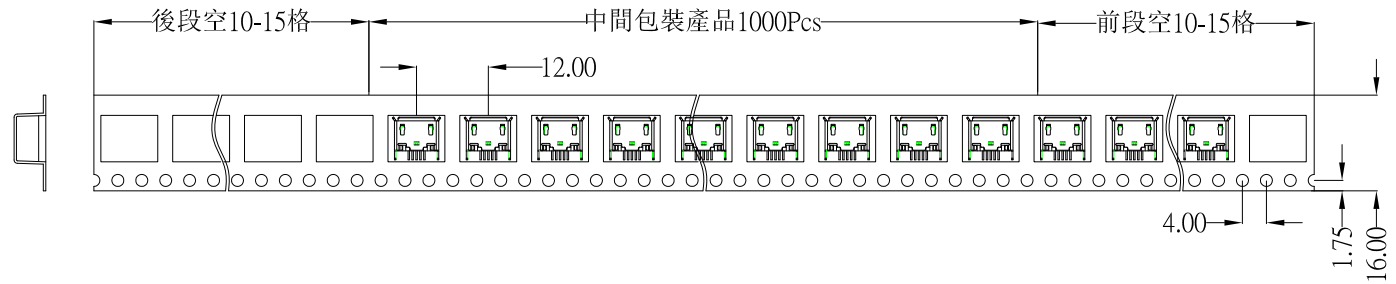

1.0K/盤

1. 每盤前後各空10-15個空格, 中間包裝 10 00PCS.
2. 每箱包裝10盤, 共包裝 10, 000PCS.

RoHS Compliant

TOLERANCES ARE

MORETHANALL
PCB CONNECTORS
Cable ASSEMBLIES

煜倫股份有限公司

www.morethanall.com

DRAWING BY CY

CHECKED BY GENIUS

UNIT/mm SCALE 1:1

DATE

SIZE A4

PJECTION

Up to 5 ±0.2
Above 5 ~ 15 ±0.3
Above 15 ~ 30 ±0.4
Above 30 ~ 50 ±0.5
Angle ±0.3°

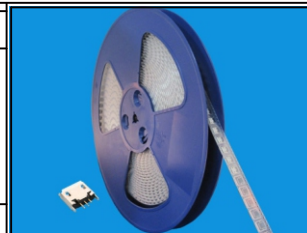

ORDER INFORMATION

MISB-SDM2R-5AB-LF
SERIES | LEADFREE
5 PIN AB TYPE
REEL
METAL FOOT
DIP 180°
FEMALE

DESCRIPTION: MICRO USB AB TYPE VERTICAL