

Specifications:

Current rating:3.0 Amps
 Voltage rating:250 AC,DC
 Contact resistance:20mohm max.
 Insulation resistance:1,000Mohm min.
 Dielectric Withstanding:600V AC/Minute
 Operating Temperature:-40°C ~ +105°C
 Materials:

Insulator:High Tempe. Plastic (PBT UL94V-0)
 Standard Color:Black
 Contact:Brass
 Plating:Selective Gold Plated

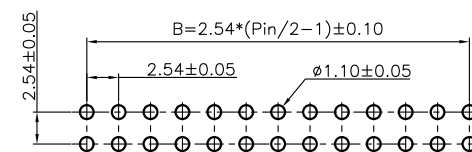
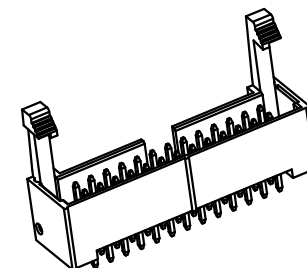

Recommended PCB Layout

Dimension :

Pos	Dim A	Dim B	Pos	Dim A	Dim B	Pos	Dim A	Dim B
6	15.24	5.08	16	27.94	17.78	34	50.80	40.64
8	17.78	7.62	20	33.02	22.86	40	58.42	48.26
10	20.32	10.16	24	38.10	27.94	50	71.12	60.96
12	22.86	12.70	26	40.64	30.48	60	83.82	73.66
14	25.40	15.24	30	45.72	35.56	64	88.90	78.74

RoHS Compliant

TOLERANCES ARE

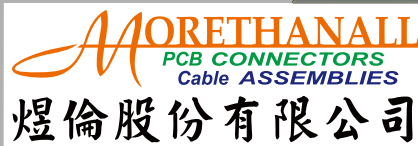

DRAWING BY CY

CHECKED BY GENIUS

UNIT / mm SCALE 1 : 1

DATE

SIZE A4

X, ±
 X, ±
 .XX ±
 .XXX ±
 ANG ±

P PROJECTION

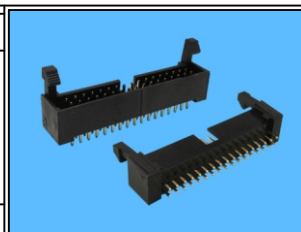

ORDER INFORMATION

FL-DG-xx-LF
 SERIES | T | LEADFREE
 | | 06-64WAY
 | | GOLD
 | | DIP 180°

DESCRIPTION: 2.54mm Box Header Straight Type

www.morethanall.com

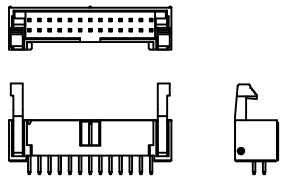

2316S-XXG-01-F1

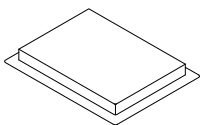

COVER TRAY

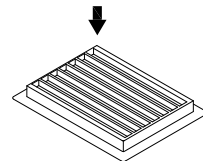

BOTTOM TRAY

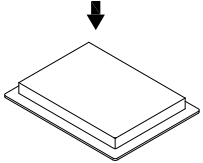

TRAY

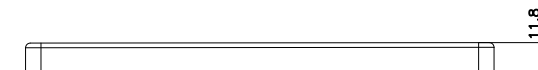
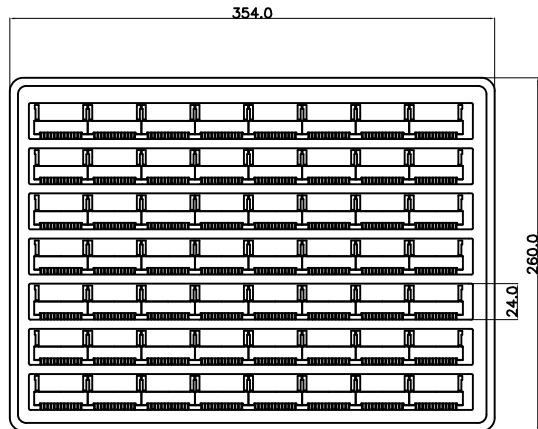

TRAY LAYOUT 902-2316S-01

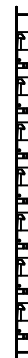

NOTE:

1. DIMENSION

TRAY SIZE: 354(L) x 260(W) x 11.8(H) (MM)

CARTON SIZE: 360(L) x 270(W) x 300(H) (MM)

2. QUANTITY

CIRCUITS	PCS/TRAY	TARYS/CARTON	Q'TY
06	140	23	3220
08	119	23	2737
10	105	23	2415
12	91	23	2093
14	84	23	1932
16	77	23	1771
20	63	23	1449
24	56	23	1288
26	49	23	1127
30	42	23	966
34	42	23	966
40	35	23	805
50	28	23	644
60	21	23	483
64	21	23	483

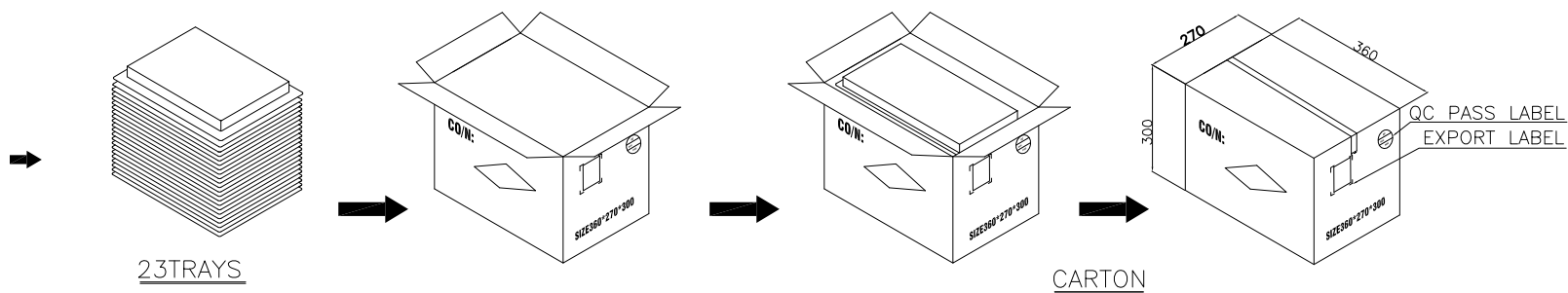

23TRAYS

CARTON

RoHS Compliant

TOLERANCES ARE

MORETHANALL
PCB CONNECTORS
Cable ASSEMBLIES

DRAWING BY CY

CHECKED BY GENIUS

UNIT / mm SCALE 1 : 1

DATE

SIZE A4

X, ±
.X ±
.XX ±
.XXX ±
ANG ±

PPOJECTION

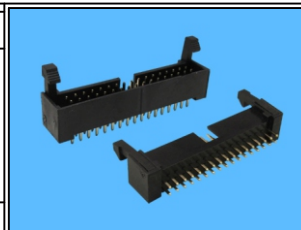

ORDER INFORMATION

FL-DG-xx-LF
SERIES | T | LEADFREE
06-64WAY
GOLD
DIP 180°

煜倫股份有限公司

www.morethanall.com

DESCRIPTION: 2.54mm Box Header Straight Type Packing List