

TAPE ON REEL TYPE

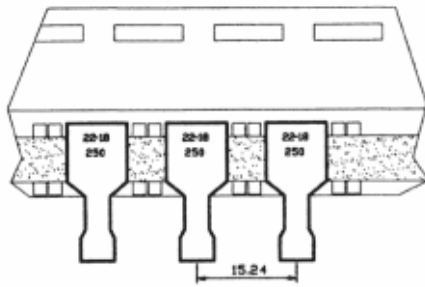

S=1:1

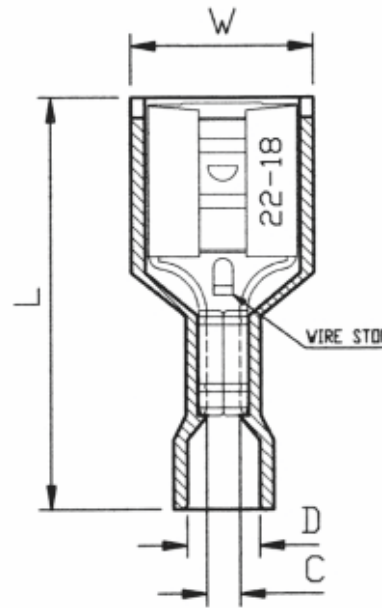
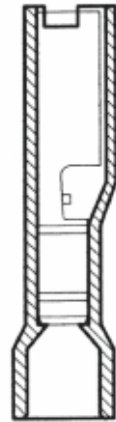
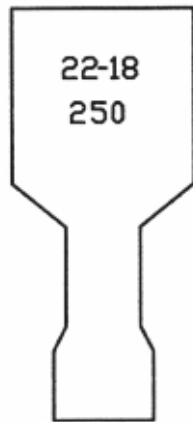

NOTE :

- 1.TERMINAL PLATING :TIN(Sn)
- 2.FLAMMABILITY RATING :UL94V-2
- 3.INSULATION SIZE :3.43mm MAX D.A.
- 4.WIRE RANGE :22-18A.W.G
- 5.MAXIMUM ELECTRICAL RATING :
105° C 600 VOLTS MAX.
- 6.TERMINAL MATERIAL :BRASS(H)
- 7.INSULATION MATERIAL :NYLON
- 8.INSULATION COLOR :RED
- 9.THICKNESS :0.4

公差 TOLERANCE 項目 ITEM	NEMA TAB	W ±0.20	L ±1.00	D ±0.30	C ±0.20	WIRE STRIP LENGTH
尺寸 SIZE	.032*250 (0.8*6.35)	9.30	21.00	3.70	1.60	6.50

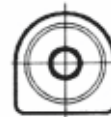

RoHS Compliant

TOLERANCES ARE

MORETHANALL
PCB CONNECTORS
Cable ASSEMBLIES

煜倫股份有限公司

www.morethanall.com

DRAWING BY CY

CHECKED BY GENIUS

UNIT/mm

SCALE 1:1

DATE

SIZE A4

PJECTION

X, ±
.X ±
.XX ±
.XXX ±
ANG ±

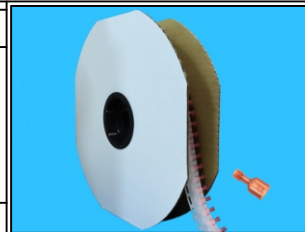

ORDER INFORMATION

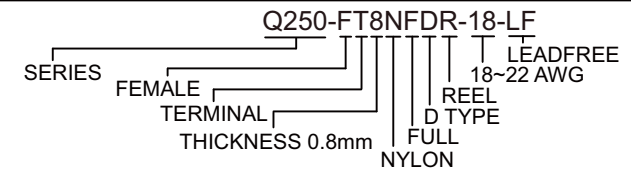

DESCRIPTION: