

- ※ 1. 凡標註 \triangle 記號者為品管管制尺寸。
- 2. 請注意第 3,4 項端子與鐵腳平面度公差需一致(同為正或同為負)。

MATERIALS:

PLASTIC HOUSING: HIGH TEMP. THERMOPLASTIC

CONTACTS: PHOSPHOR BRONZE

PLATING: GOLD PLATING OVER NICKEL IN CONTACT.

TIN PLATING OVER NICKEL IN SOLDER AREA.

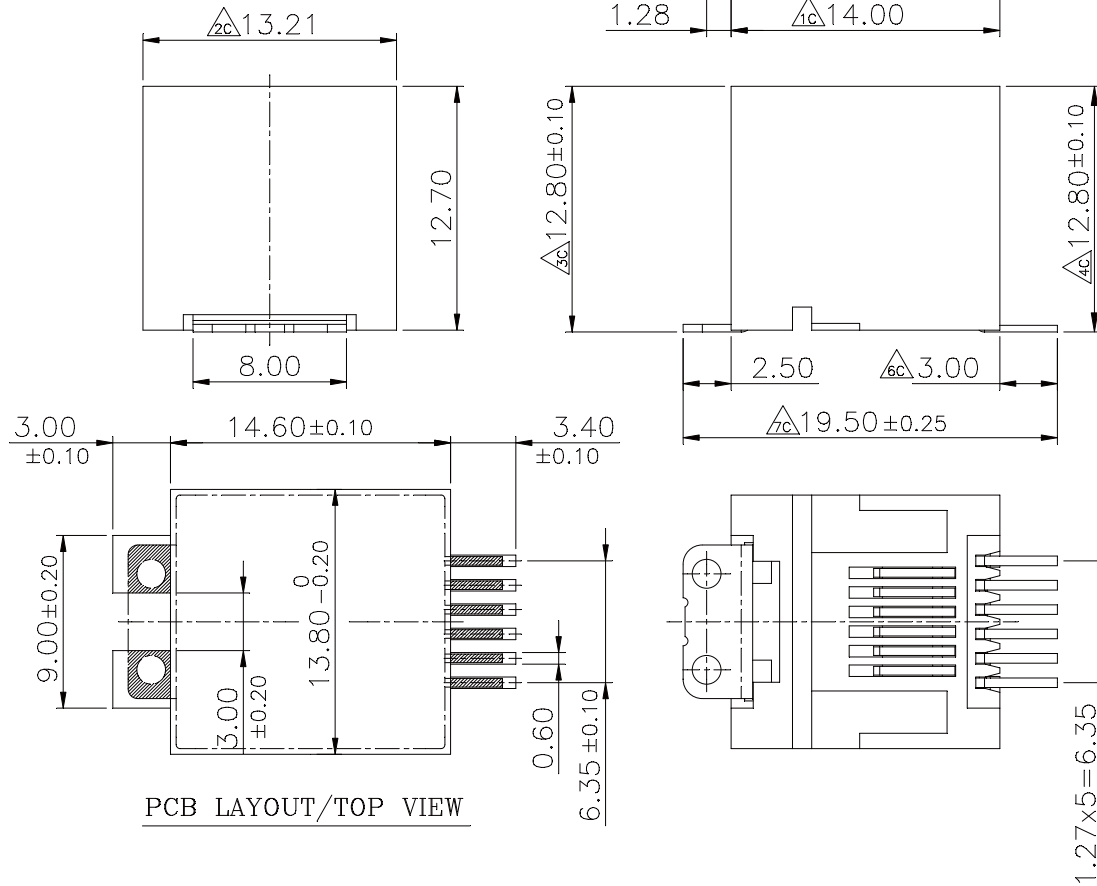

PCB LAYOUT/TOP VIEW

RoHS Compliant



煜倫股份有限公司

www.morethanall.com

DRAWING BY CY

CHECKED BY GENIUS

UNIT/mm

SCALE 1:1

DATE

SIZE A4

PJECTION

TOLERANCES ARE

X. \pm
 .X ± 0.38
 .XX ± 0.25
 .XXX ± 0.10
 ANG $\pm 3^\circ$

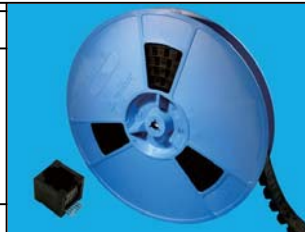

ORDER INFORMATION

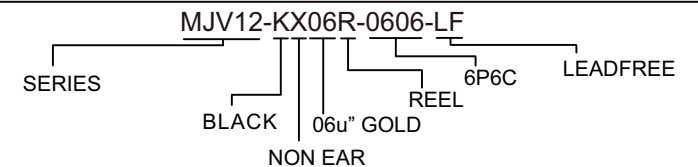

DESCRIPTION: TOP ENTRY SMT JACK(6P6C)

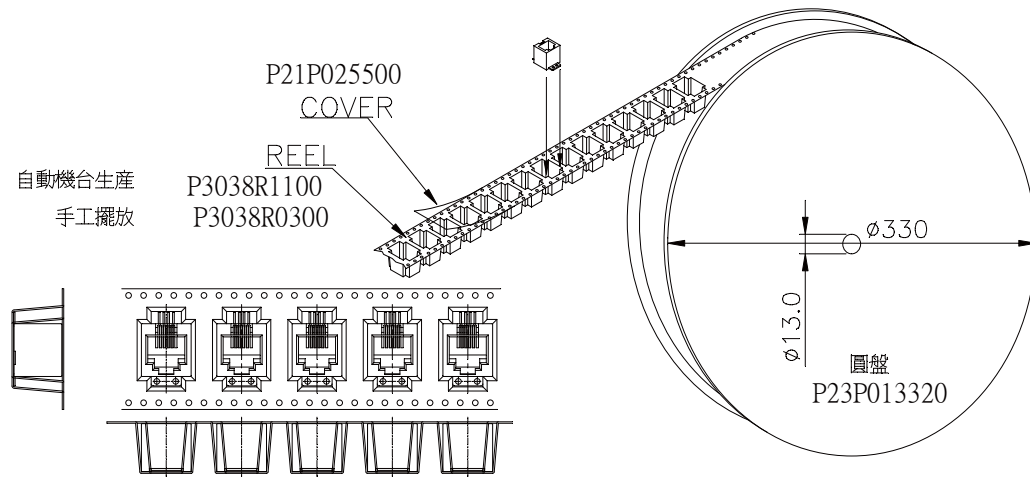

1. 請將組立完成之成品依圖面標示方向順序放入口袋內，前空5格，後空5格，封上P21P025500，每盤裝230 Pcs。

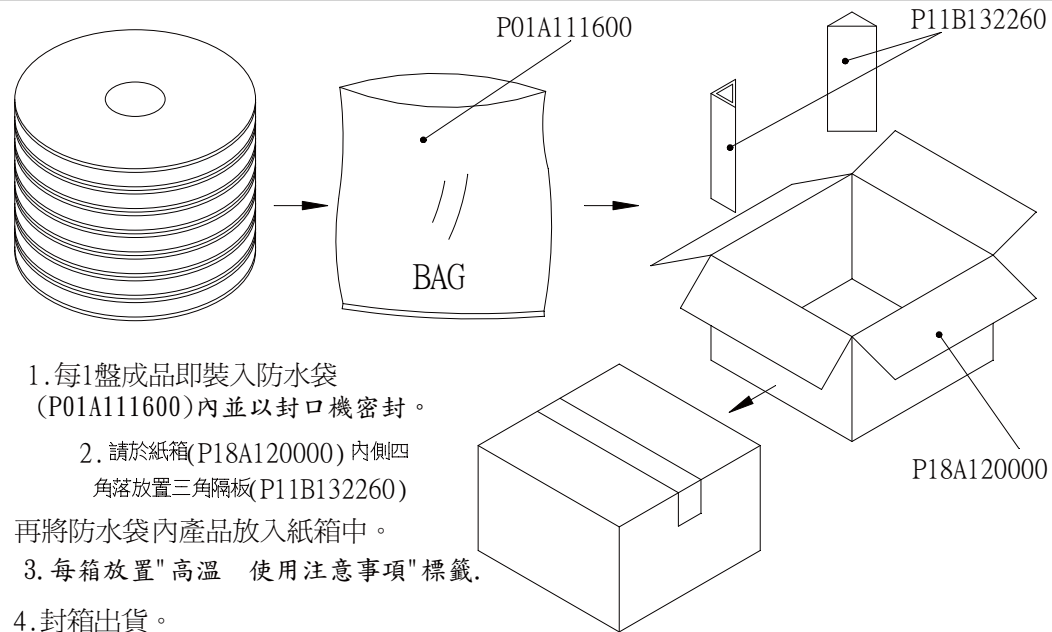

1. 每1盤成品即裝入防水袋 (P01A111600)內並以封口機密封。
2. 請於紙箱(P18A120000)內側四角放置三角隔板(P11B132260)再將防水袋內產品放入紙箱中。
3. 每箱放置"高溫 使用注意事項"標籤。
4. 封箱出貨。

RoHS Compliant

TOLERANCES ARE

MORETHANALL
PCB CONNECTORS
Cable ASSEMBLIES

DRAWING BY CY

CHECKED BY GENIUS

UNIT/ mm SCALE 1:1

DATE

SIZE A4

X, ±
.X ± 0.38
.XX ± 0.25
.XXX ± 0.10
ANG ± 3°

P PROJECTION

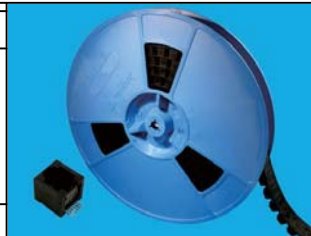

ORDER INFORMATION

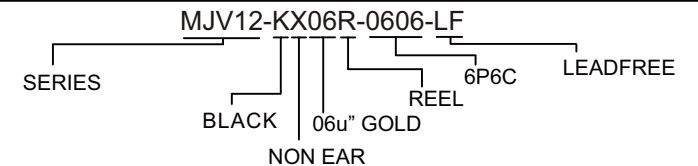

DESCRIPTION: TOP ENTRY SMT JACK(6P6C)

煜倫股份有限公司

www.morethanall.com