

3P-12P

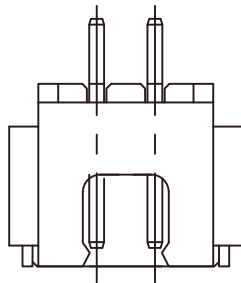
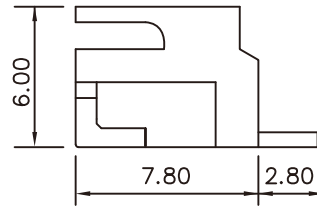
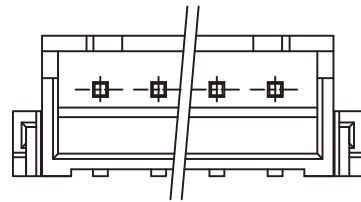
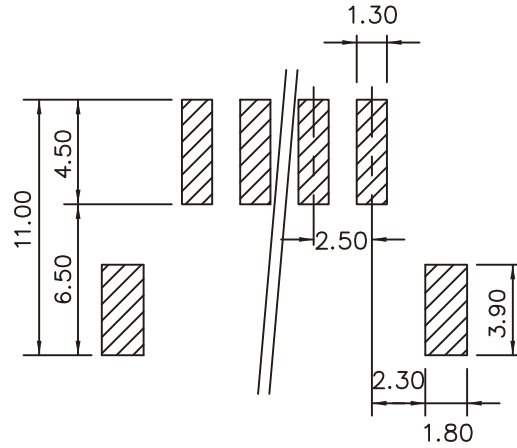

2P

Specifications

Current Rating: 3A AC, DC
 Voltage Rating: 250V AC Maximum
 Operating Temp: -25°C ~ +85°C
 Contact Resistance: 10mΩ Max
 Insulation Resistance: 1000MΩ Min
 Withstanding Voltage: 1000V AC/minute
 Pin: Brass/Gold Flash
 Wafer: Nylon 6T, UL94V-0
 Solder Tab: Brass/Tin Plated

Poles	Dimension mm	
	A	B
2	2.5	10.0
3	5.0	12.5
4	7.5	15.0
5	10.0	17.5
6	12.5	20.0
7	15.0	22.5
8	17.5	25.0
9	20.0	27.5
10	22.5	30.0
11	25.0	32.5
12	27.5	35.0

RoHS Compliant

TOLERANCES ARE

MORETHANALL
 PCB CONNECTORS
 Cable ASSEMBLIES

DRAWING BY CY

CHECKED BY GENIUS

UNIT / mm

SCALE 1:1

DATE

SIZE A4

X.±
 .X±
 .XX±
 .XXX±
 ANG±

PPOJECTION

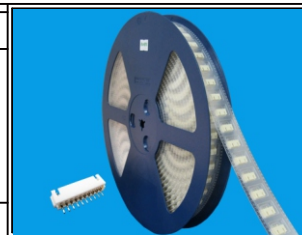

ORDER INFORMATION

XH-WGR-xx-LF
 SERIES | REEL | LEADFREE
 | | 02-12 WAY
 | | GOLD
 | | 90°SMT

煜倫股份有限公司

www.morethanall.com

DESCRIPTION: XH2.5mm Wire-to-Board Header SMT 90° Type

(2 to 3 circuits)

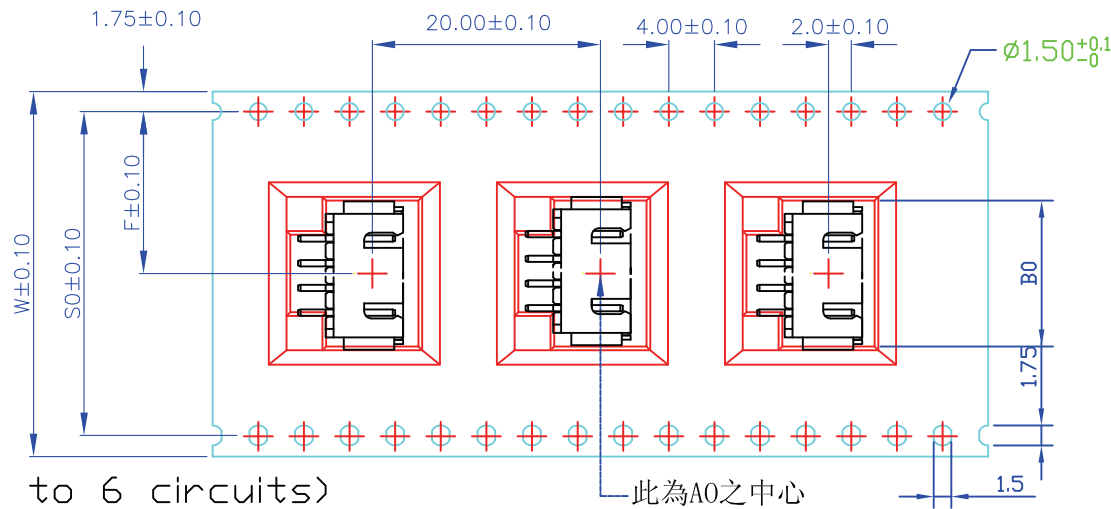
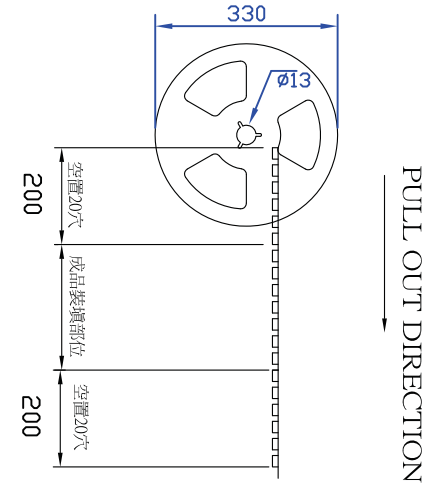
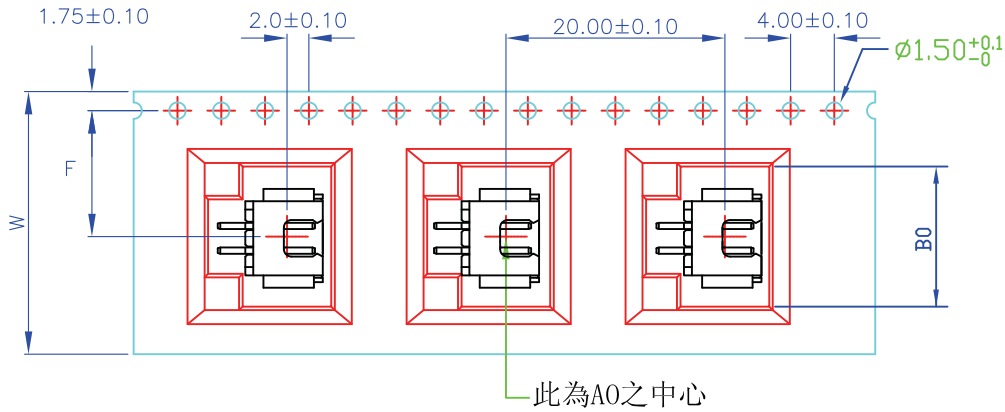

P=Poles	W	F	S	B0	Q'TY/Reel
02	24	11.5	/	10.3	500PCS
03	24	11.5	/	12.8	500PCS
04	32	14.2	28.4	15.3	500PCS
05	32	14.2	28.4	17.8	500PCS
06	32	14.2	28.4	20.3	500PCS

(4 to 6 circuits)

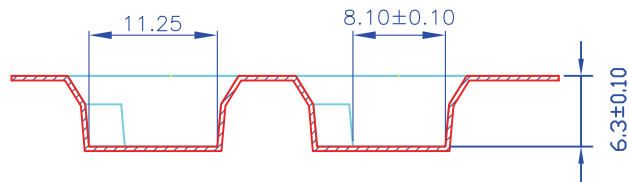

RoHS Compliant

TOLERANCES ARE

MORETHANALL
PCB CONNECTORS
Cable ASSEMBLIES

DRAWING BY CY

X.±

CHECKED BY GENIUS

.X±

UNIT / mm

SCALE 1 : 1

.XX±

DATE

.XXX±

SIZE A4

PJECTION

ANG±



ORDER INFORMATION

XH-WGR-xx-LF
SERIES | REEL | LEADFREE
02-12 WAY
GOLD
90°SMT

煜倫股份有限公司

www.morethanall.com

DESCRIPTION: XH2.5mm Wire-to-Board Header SMT 90° Type