

主要技术参数 Main Specifications

线数 (Poles): 02 to 16
 接触电阻 (Contact resistance): $\leq 20m\Omega$
 绝缘电阻 (Insulation resistance): $\geq 1000M\Omega$
 额定电压 (Rated voltage): 250V AC DC
 额定电流 (Rated current): 3.0A AC DC
 耐电压 (Withstand Voltage): 1000V AC/minute
 温度范围 (Temperature Range): $-25^{\circ}C \sim +105^{\circ}C$

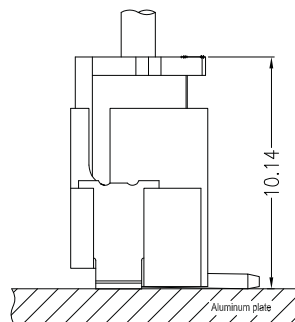
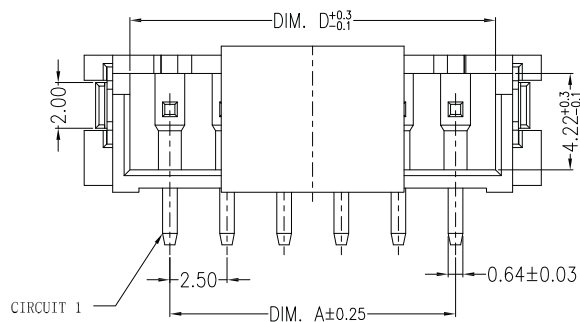

Assembly Layout

Circuit	Dimensions (mm)			
	DIM. A	DIM. B	DIM. C	DIM. D
02	2.50	7.50	10.00	6.00
03	5.00	10.00	12.50	8.50
04	7.50	12.50	15.00	11.00
05	10.00	15.00	17.50	13.50
06	12.50	17.50	20.00	16.00
07	15.00	20.00	22.50	18.50
08	17.50	22.50	25.00	21.00
09	20.00	25.00	27.50	23.50
10	22.50	27.50	30.00	26.00
11	25.00	30.00	32.50	28.50
12	27.50	32.50	35.00	31.00
13	30.00	35.00	37.50	33.50
14	32.50	37.50	40.00	36.00
15	35.00	40.00	42.50	38.50
16	37.50	42.50	45.00	41.00

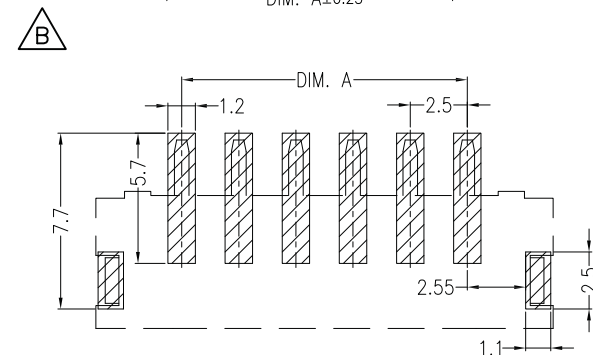

SUGGESTED PCB LAYOUT

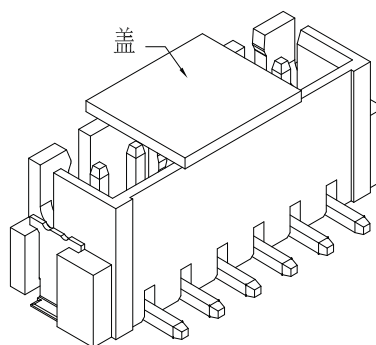

ITEM	COMPONENT	Q'TY	MATERIAL	FINISH
C	SOLDER TAB	2 PCS	PhosphorBronze	Sn-plated
B	CONTACT	2~16 PCS	Brass	Sn-plated
A	PEDESTAL	1 PCS	LCP	UL 94V-0, COLOR:BEIGE

RoHS Compliant

TOLERANCES ARE

MORETHANALL
PCB CONNECTORS
Cable ASSEMBLIES

DRAWING BY CY

X, ±

CHECKED BY GENIUS

.X ± 0.30

UNIT / mm

SCALE 1 : 1

.XX ± 0.25

DATE

.XXX ±

ANG ± 3°

SIZE A4

PPOJECTION

照片框

ORDER INFORMATION

XH-VCR-xx-LF
 SERIES | REEL | LEADFREE
 | | 02~16WAY
 CAP 180°SMT

煜倫股份有限公司

www.morethanall.com

DESCRIPTION: 2.5mm PITCH 180°WAFER SMT TYPE

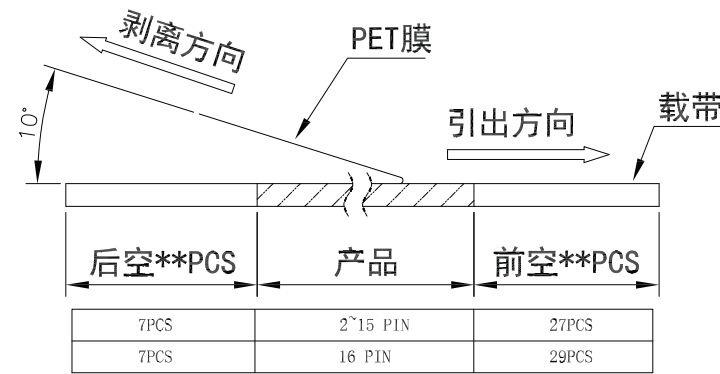
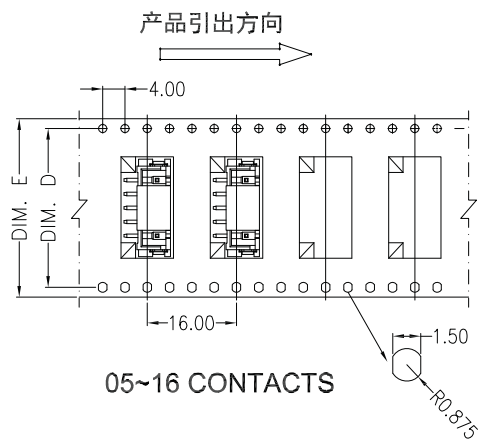
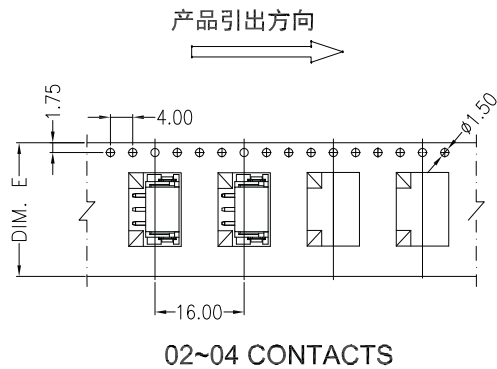

(PET膜剥离示意图)

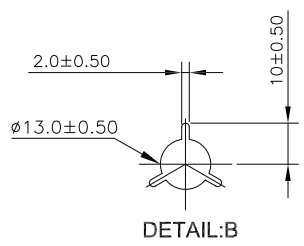
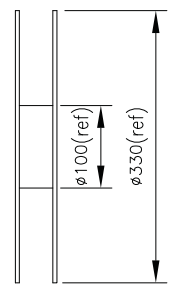
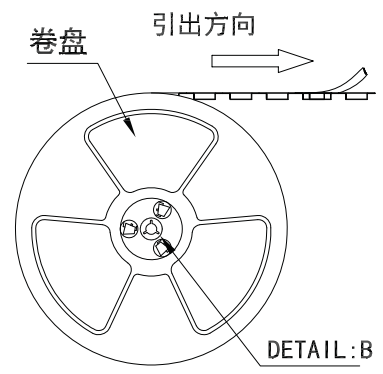

Circuits	DIM. D	DIM. E	Q'ty/Reel
02-04PIN	-	24	500PCS
05-06PIN	28.4	32	500PCS
07-10PIN	40.4	44	500PCS
11-15PIN	52.4	56	500PCS
16PIN	68.4	72	450PCS

RoHS Compliant

TOLERANCES ARE

MORETHANALL
PCB CONNECTORS
Cable ASSEMBLIES
煜倫股份有限公司
www.morethanall.com

DRAWING BY CY		X. ± .X ± 0.30 .XX ± 0.25 .XXX ± ANG ± 3°
CHECKED BY GENIUS		
UNIT / mm	SCALE 1 : 1	
DATE		
SIZE A4	PJECTION	



ORDER INFORMATION

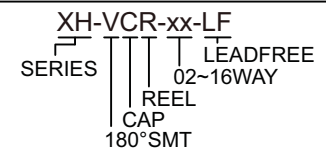

DESCRIPTION: 2.5mm PITCH 180°WAFER SMT TYPE