

NOTES:

1. MATERIAL:
 - 1.1 HOUSING: ENGINEERING THERMOPLASTIC, UL94V-0, COLOR:BLACK.
 - 1.2 SEAL: SILICON, COLOR:RED.
 - 1.3 GASKET: SILICON, COLOR:RED.
2. APPLICABLE ETHERNET CABLE DIAMETER RANGE $\phi 7 \sim \phi 5.5$
3. \triangle MARK FOR QUALITY CONTROL DEPARTMENT EXAMINE.

RoHS Compliant

TOLERANCES ARE

MORETHANALL
PCB CONNECTORS
Cable ASSEMBLIES

煜倫股份有限公司

www.morethanall.com

DRAWING BY CY

CHECKED BY GENIUS

UNIT / mm SCALE 1 : 1

DATE

SIZE A4

X. ± 0.38
X. ± 0.25
.XX ± 0.10
.XXX ± 0.05
ANG $\pm 3^\circ$

PPOJECTION

照片框

ORDER INFORMATION

WPRJ-PCBKM-0808-LF

SERIES | LEADFREE
| 8P8C
| METRIC SCREW
| BLACK
| CRIMP
| MALE

DESCRIPTION: 二代防水盒端+IDC

線端使用手冊

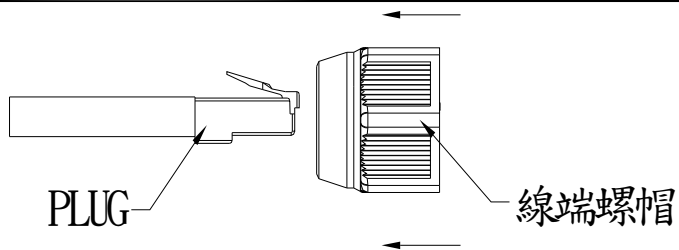

1. 將線端螺帽依圖示方向，套入已組裝完成的PLUG 中。

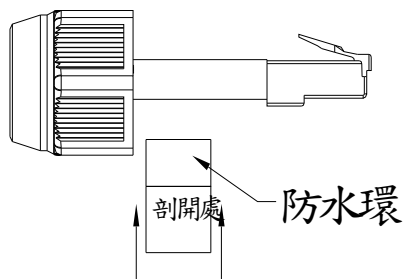

2. 將防水環的剖開處依圖示方向套上已組裝完成的CABLE.

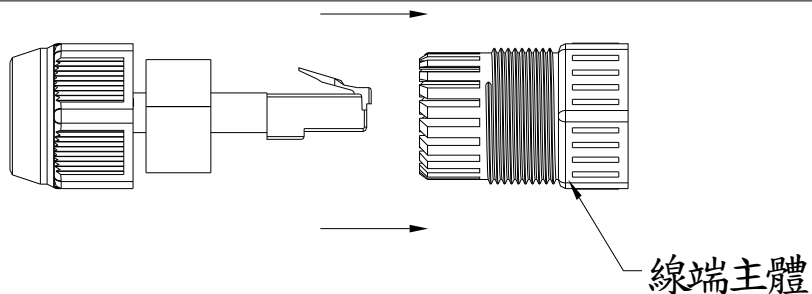

3. 請依圖示方向，先將PLUG 穿過線端主體，再將防水環推至線端主體底部，最後將線端螺帽預鎖上線端主體即可。

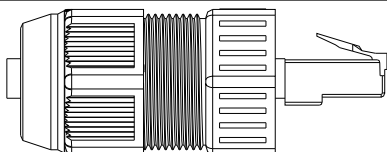

4. 此為組裝完成之線端組立圖。

線&盒端使用手冊

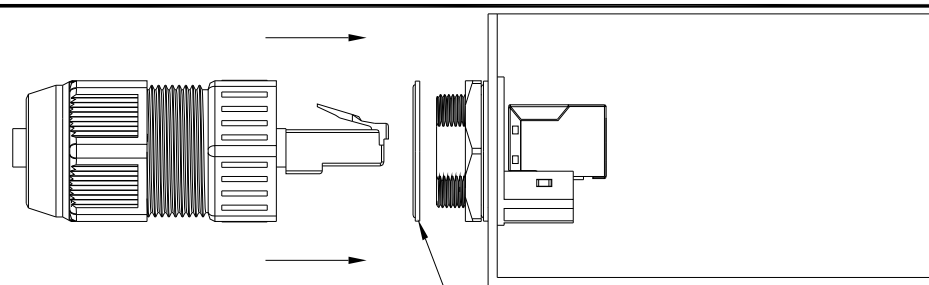

大墊片

1. 請依圖示方向先將大墊片放至盒端螺帽上，再將PLUG插入防水盒中。

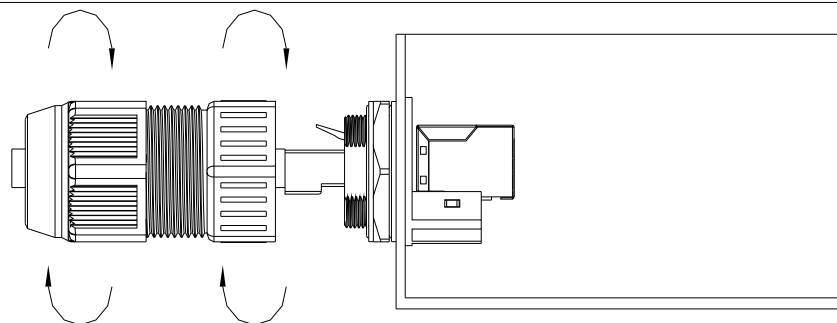

2. 請圖示先將線端主體和防水盒端旋緊，再將盒端螺帽和防水盒端旋緊即可。

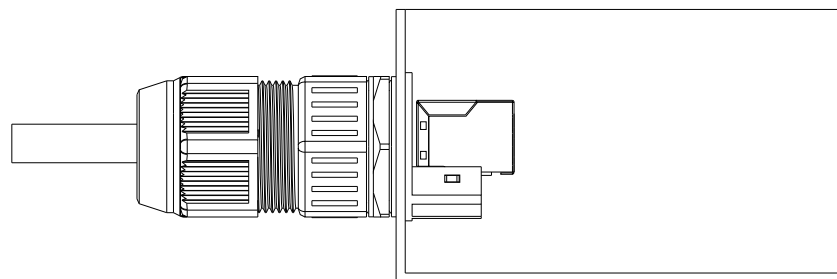

3. 此為組裝完成之成品組立圖。