

### UL-PDP-3X02

### UL-PDP-3X03

### UL-PDP-3X04

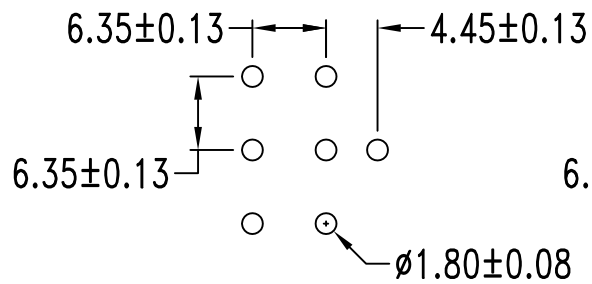
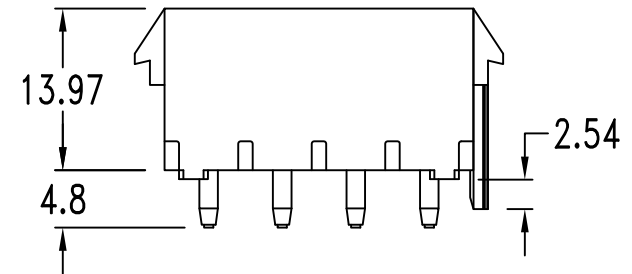
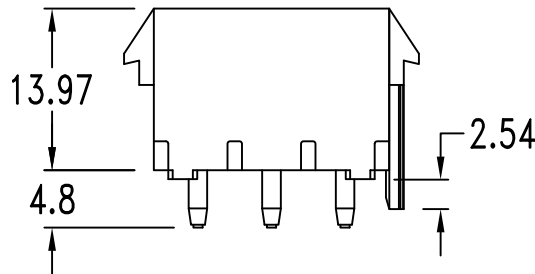
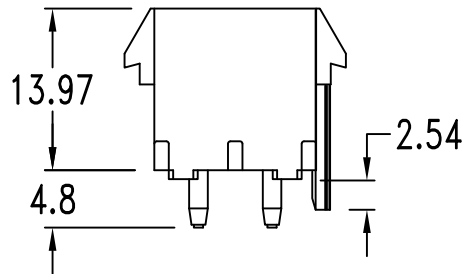
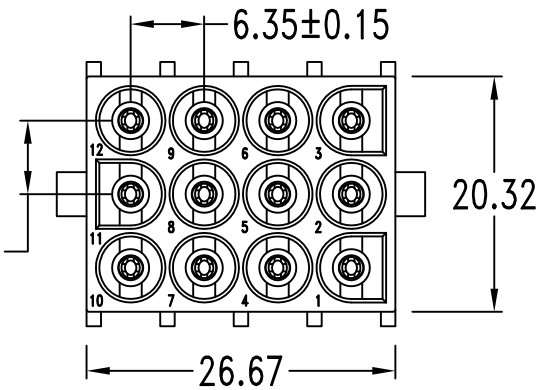
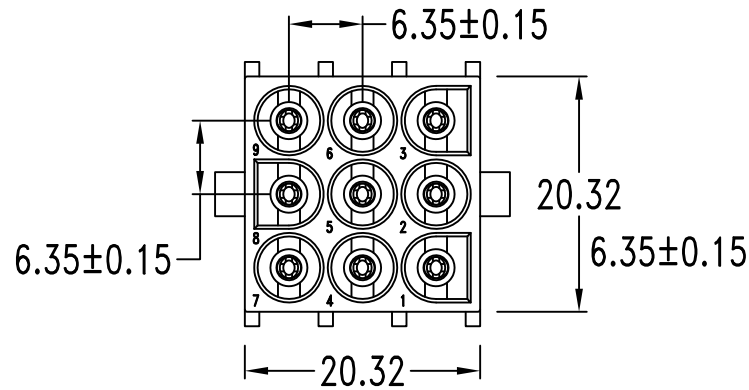
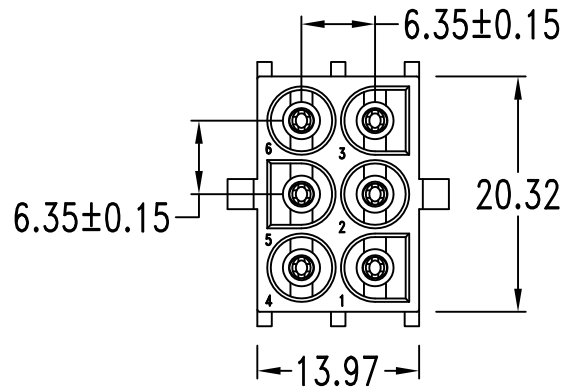

P. C. board layout

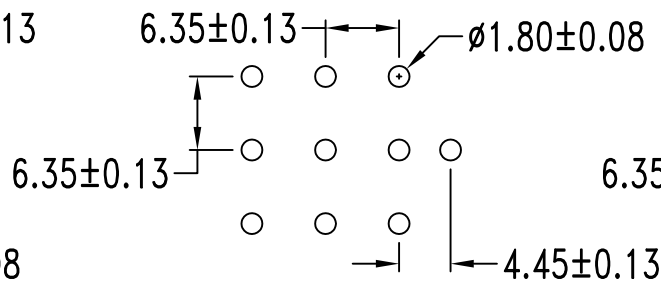

P. C. board layout

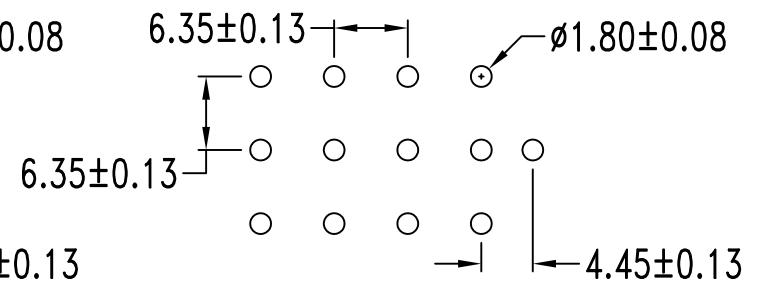

P. C. board layout

**RoHS Compliant**

TOLERANCES ARE

**MORETHANALL**  
PCB CONNECTORS  
Cable ASSEMBLIES

DRAWING BY CY

X, ±

CHECKED BY GENIUS

.X ±

UNIT / mm SCALE 1 : 1

.XX ±

DATE

.XXX ±

SIZE A4

PPOJECTION

ANG ±

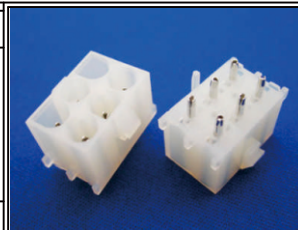

**ORDER INFORMATION**

UL-PDP-3Xxx-LF  
SERIES | LEADFREE  
3X02:06WAY  
3X05:15WAY  
POST  
DIP 180°  
MALE HOUSING

**煜倫股份有限公司**

www.morethanall.com

DESCRIPTION:

# UL-PDP-3X05

## Features:

- 2 ~ 10, 12, 15 circuits available
- Pin Material: Tin-plated phosphor bronze or Gold Flash
- Standard Color: Nature

## Specification:

- Current rating: 13A (2~4P), 11A (6~15P)
- Voltage rating: 600V
- Dielectric withstanding voltage: 5000V AC/minute
- Ambient temperature rise: -55°C ~ 105°C

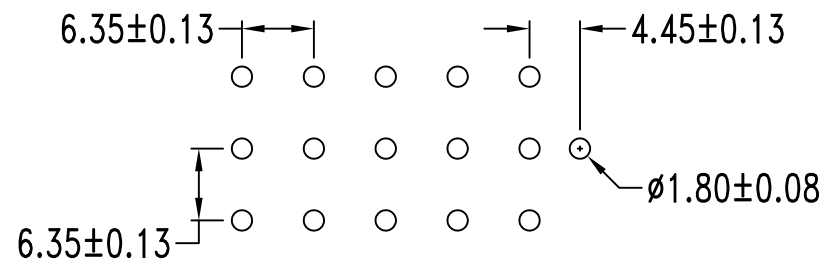
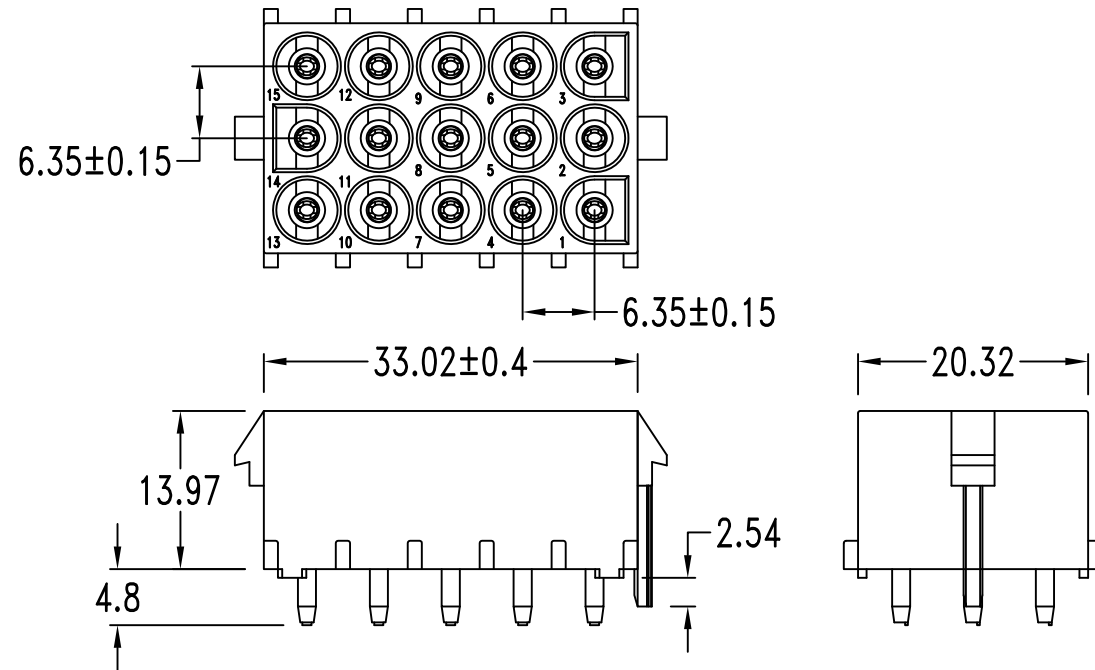

P. C. board layout



煜倫股份有限公司

www.morethanall.com

RoHS Compliant

DRAWING BY CY

CHECKED BY GENIUS

UNIT / mm SCALE 1 : 1

DATE

SIZE A4

TOLERANCES ARE

X.  $\pm$

.X  $\pm$

.XX  $\pm$

.XXX  $\pm$

ANG  $\pm$

P PROJECTION

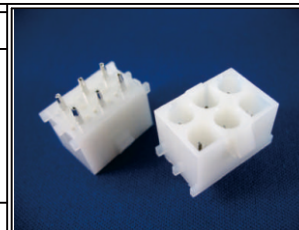

ORDER INFORMATION

UL-PDP-3Xxx-LF  
 SERIES LEADFREE  
 3X02:06WAY  
 3X05:15WAY  
 POST  
 DIP 180°  
 MALE HOUSING

DESCRIPTION: