

TYPE 1
POWER SUPPLY 2.5 V

TYPE 2
POWER SUPPLY 1.8 V

DETAIL E
MECHANICAL KEY TYPE

1.8V	TYPE 2
2.5V	TYPE 1
POWER SUPPLY	KEY TYPE

NOTES.

- 材質: ハウジング: LCP樹脂、UL94V-0、色: 黒色
 コンタクト: 銅合金
 メタルラッチ: ステンレス
 MATERIAL: HOUSING: LCP, UL94V-0, COLOR: BLACK
 CONTACT: COPPER ALLOY
 METAL LATCH: SUS
 メッキ: コンタクト (接点部、半田付け部): 金メッキ0.0075μmMIN, ニッケル下地1.5μmMIN.
 PLATING: CONTACT (CONTACT POINT, SOLDER AREA):
 Au PLATE 0.0075μm MIN, Ni UNDER PLATE 1.5μm MIN.
- コネクタを平坦面に置き、端子半田付け部の浮きは、0.1mm以下
 MUST BE MEASURED FLOATING AMOUNT OF CONTACT TAILS
 FROM DATAM SURFACE IS 0.1mm MAX.

- 倍率適用外寸法
NOT TO SCALE.
- 公差非累積
TOLERANCES NON-CUMULATIVE
- 他社のソケット用
FOR SOCKET OF THE OTHER COMPANIES

RoHS Compliant

TOLERANCES ARE

MORETHANALL
PCB CONNECTORS
Cable ASSEMBLIES
煜倫股份有限公司
www.morethanall.com

DRAWING BY CY	X, ±
CHECKED BY GENIUS	.X ±
UNIT / mm	.XX ±
SCALE 1:1	.XXX ±
DATE	ANG ±
SIZE A4	PJECTION



ORDER INFORMATION

SDM8-W52Vxx-038106-LF
 SERIES | V18:1.8V | 38+106 WAY
 | V25:2.5V |
 | HIGH 5.2mm |
 | 90°SMT |

DESCRIPTION:

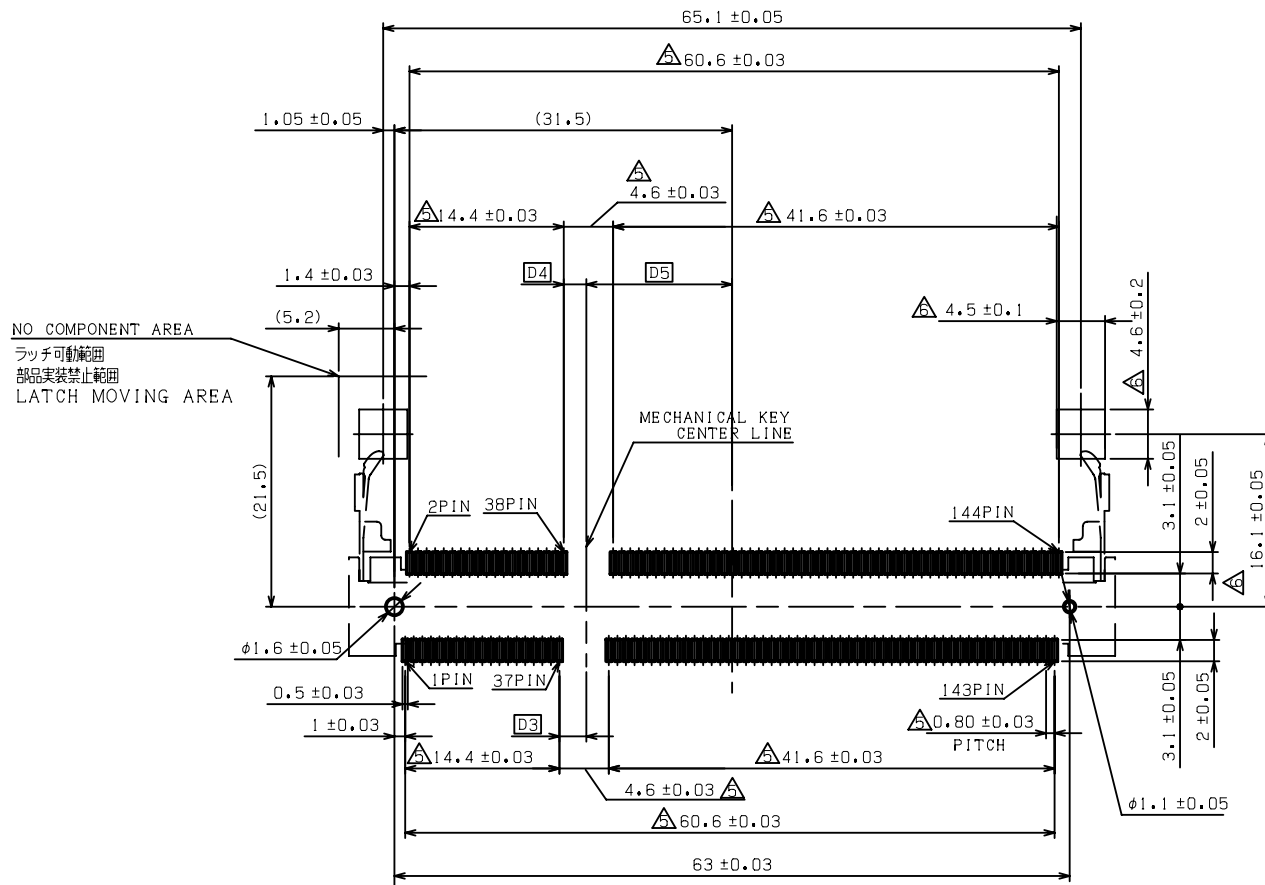

NO COMPONENT AREA
 ラッチ可動範囲
 部品実装禁止範囲
 LATCH MOVING AREA

推奨基板レイアウト寸法
 RECOMMENDED MOUNTING
 P.C. BOARD PATTERN LAYOUT DIM.

	1.8V	13.60	2.10	2.50
	2.5V	14.35	1.35	1.75
POWER SUPPLY		D5	D4	D3

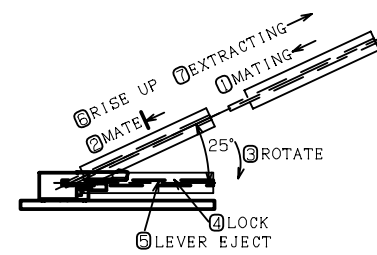

HOW TO MATE AND UNMATE
 MATE ① - ④
 UNMATE ⑤ - ⑦

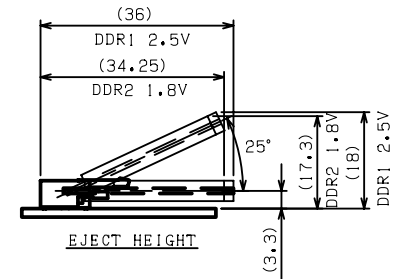

MORETHANALL
 PCB CONNECTORS
 Cable ASSEMBLIES

煜倫股份有限公司

www.morethanall.com

RoHS Compliant

DRAWING BY CY

CHECKED BY GENIUS

UNIT / mm SCALE 1:1

DATE

SIZE A4

TOLERANCES ARE

X. ±
 .X ±
 .XX ±
 .XXX ±
 ANG ±

PJECTION

照片框

ORDER INFORMATION

SDM8-W52Vxx-038106-LF

SERIES

38+106 WAY
 V18:1.8V
 V25:2.5V
 HIGH 5.2mm
 90°SMT

DESCRIPTION:

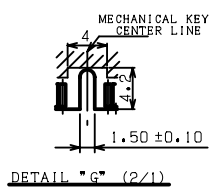
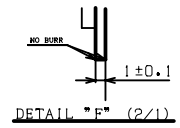
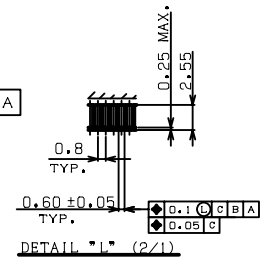
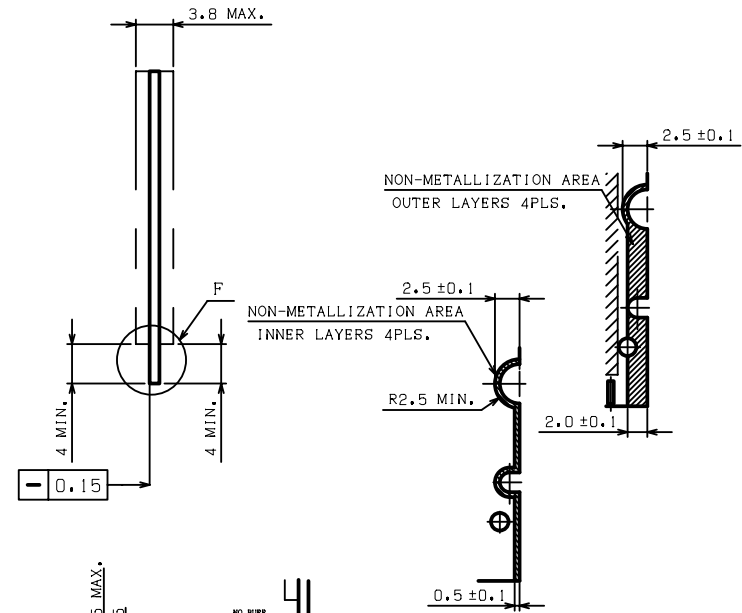
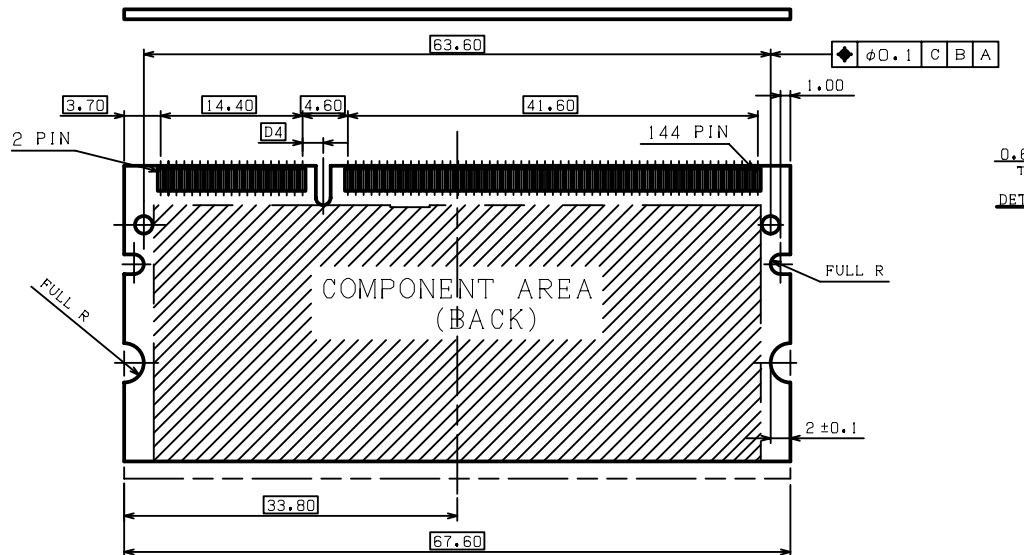
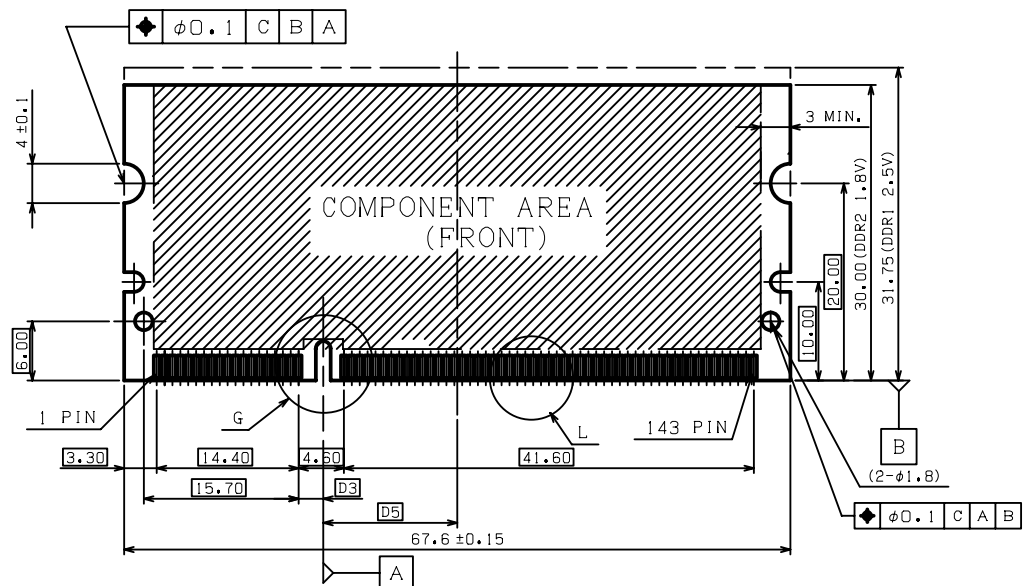

1.8V	13.60	2.10	2.50
2.5V	14.35	1.35	1.75
POWER SUPPLY	D5	D4	D3

RoHS Compliant

TOLERANCES ARE

MORETHANALL
PCB CONNECTORS
Cable ASSEMBLIES
煜倫股份有限公司
www.morethanall.com

DRAWING BY CY
CHECKED BY GENIUS
UNIT / mm SCALE 1:1
DATE
SIZE A4

X. ±
.X ±
.XX ±
.XXX ±
ANG ±

照片框

ORDER INFORMATION

SDM8-W52Vxx-038106-LF
SERIES
38+106 WAY
V18:1.8V
V25:2.5V
HIGH 5.2mm
90°SMT

DESCRIPTION:

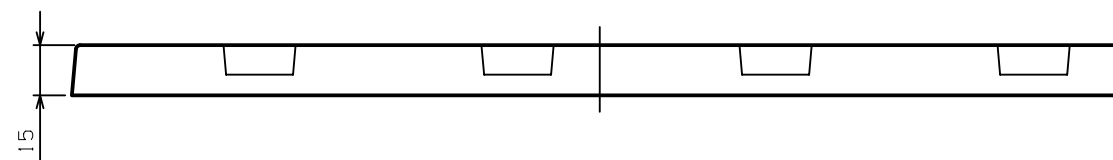
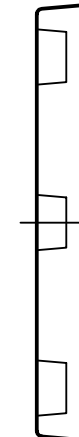
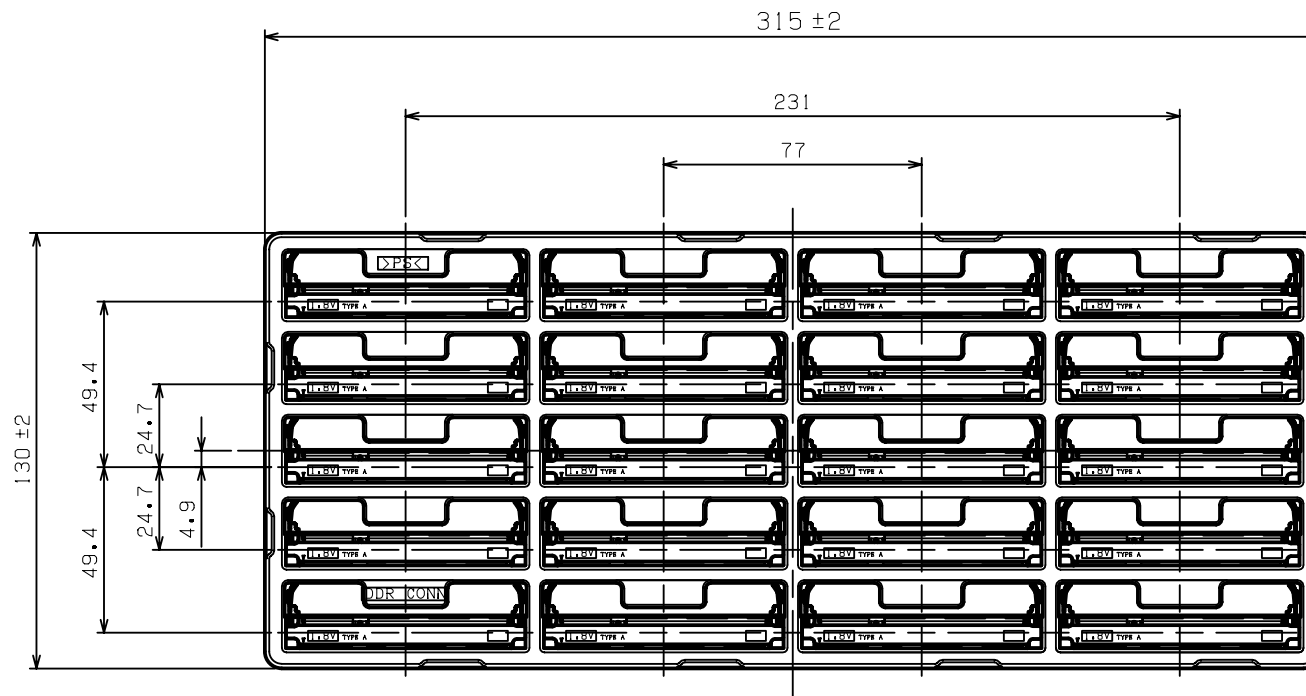

◎ SOFT TRAY PACKAGING

20	1.8V
20	2.5V
QTY.	POWER SUPPLY

RoHS Compliant

TOLERANCES ARE

MORETHANALL
PCB CONNECTORS
Cable ASSEMBLIES
煜倫股份有限公司
www.morethanall.com

DRAWING BY CY		X. ± .X ± .XX ± .XXX ± ANG ±
CHECKED BY GENIUS		
UNIT / mm	SCALE 1 : 1	
DATE		
SIZE A4	PJECTION	

照片框

ORDER INFORMATION

SDM8-W52Vxx-038106-LF
SERIES | V18:1.8V | V25:2.5V | HIGH 5.2mm | 90°SMT | 38+106 WAY

DESCRIPTION: