

SDM8-V86V33-6084-LF
LEADFREE

RoHS Compliant

MORETHANALL
CONNECTORS
ASSEMBLIES

PART NO. SDM8-V86V33-6084

DWG NO. SDM8-V86V33-6084

FILE NO.

UNIT / mm

SCALE 1:1

CHECKED BY CY

DRAWING BY

PROJECTION

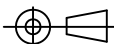

TOLERANCES ARE

.X ± 0.2
.XX ±
.XXX ±
AWG

DESCRIPTION:

AREA

REVISIONS

HK

DATE

煜倫股份有限公司

1 2 3 4 5 6 7 8 9 0

J
I
H
G
F
E
D
C
B
A

版次	修改時間	修改尺寸
A	2010/10/25	DIM_(1)3.74mm
	2010/10/25	DIM_(2)4.93mm
B	2011/3/08	DIM_(2)5.21mm

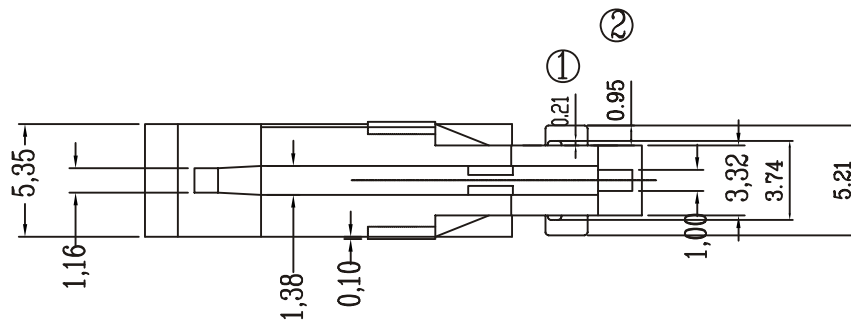
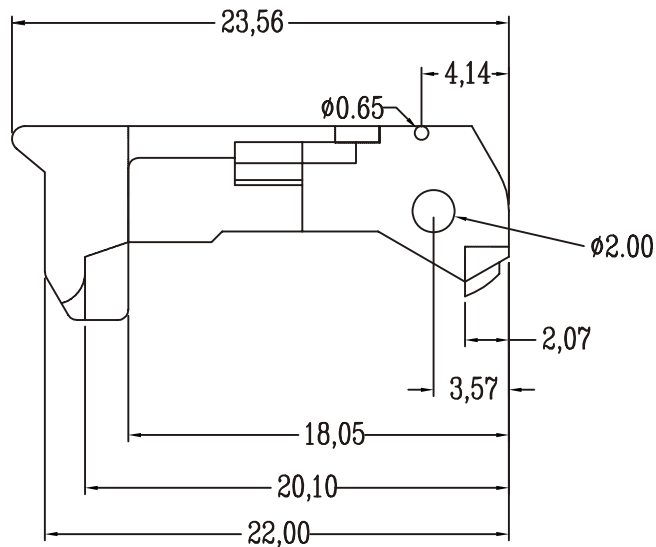
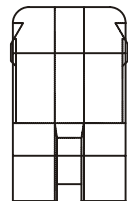

MORETHANALL
CONNECTORS
ASSEMBLIES

PART NO. SDM8-V86V33-6084

DWG NO. SDM8-V86V33-6084

CHECKED BY CY

TOLERANCES ARE

DESCRIP TION:

FILE NO.

DRAWING BY

.X ±
.XX ±
.XXX ±
AWG

AREA

REVISIONS

HK

DATE

焯倫股份有限公司

UNIT / mm

SCALE 1:1

PROJECTION

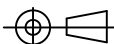

1 2 3 4 5 6 7 8 9 0

J
I
H
G
F
E
D
C
B
A

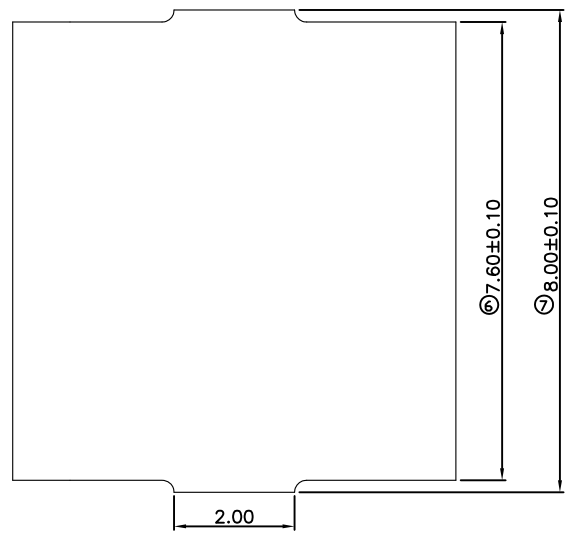

NOTES
 1. MATERIAL(素材): SUS301
 THICKNESS(厚度): 0.15±0.01 mm
 2. BURR(毛邊): 0.03mm MAX. ; DAMAGE(損壞): NA. (不可)
 3. unit:mm
 4. IMPORTANT DIM. MARK "*" "
 5. 檢測尺寸 "①~⑦"

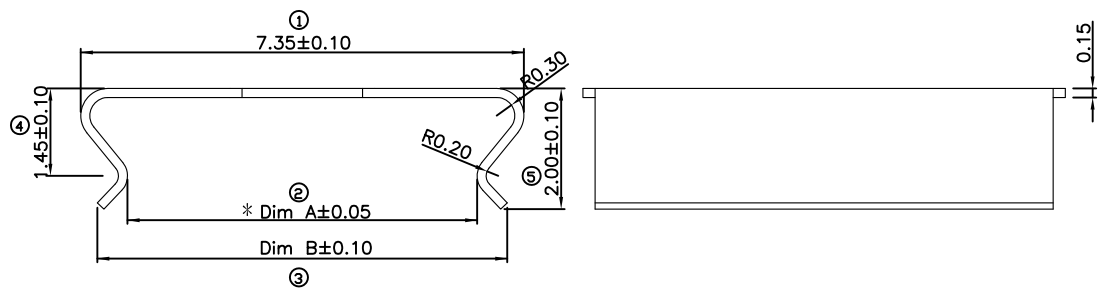

MORETHANALL
 CONNECTORS
 ASSEMBLIES

PART NO. SDM8-V86V33-6084

DWG NO. SDM8-V86V33-6084

CHECKED BY CY

TOLERANCES ARE

DESCRIPTION: DIMM Socket 144P SMT type CAP

FILE NO.

DRAWING BY

.X ± 0.2
.XX ±
.XXX ±
AWG

AREA	REVISIONS	HK	DATE
------	-----------	----	------

焯倫股份有限公司

UNIT / mm SCALE 1:1

PROJECTION

1 2 3 4 5 6 7 8 9 0

J
I
H
G
F
E
D
C
B
A

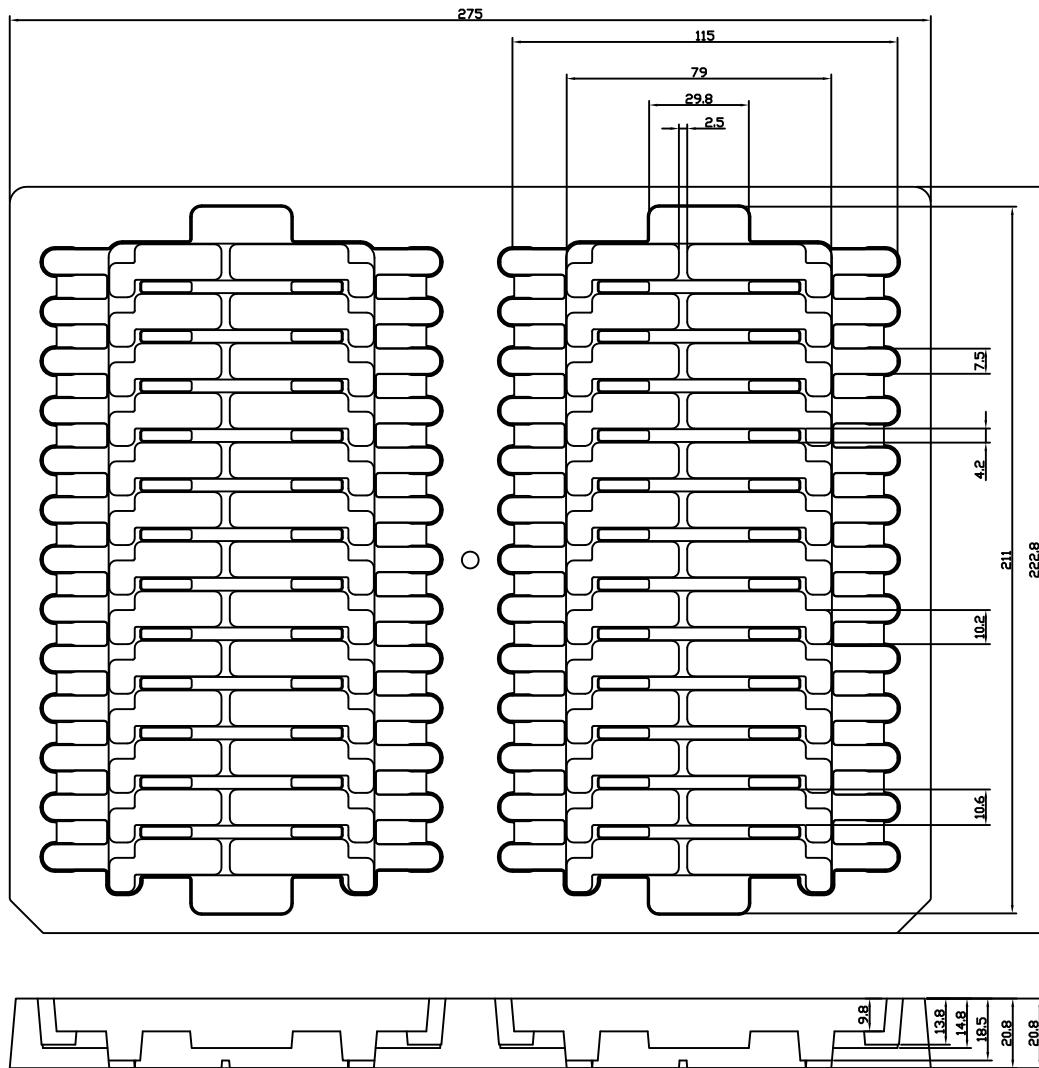

MORETHANALL
CONNECTORS
ASSEMBLIES

煜倫股份有限公司

PART NO. SDM8-V86V33-6084

DWG NO. SDM8-V86V33-6084

FILE NO.

UNIT / mm

SCALE 1:1

CHECKED BY CY

DRAWING BY

PROJECTION

TOLERANCES ARE

.X ± 0.2
.XX ±
.XXX ±
AWG

DESCRIP TION:			
AREA	REVISIONS	HK	DATE