

NOTE:
 1. SOLDER TAIL TO BE WITHIN 0.05 UPWARD AND 0.2 DOWNWARD FROM Z-DATUM PLACE, AND COPLANALITY OF SOLDER TAILS TO BE WITHIN 0.10. MEASUREMENT POINT IS SOLDER TAIL TIP.
 2. INSPECTION SYMBOL:
 ● : MANUFACTURER INSPECTION
 ◆ : Q.C INSPECTION

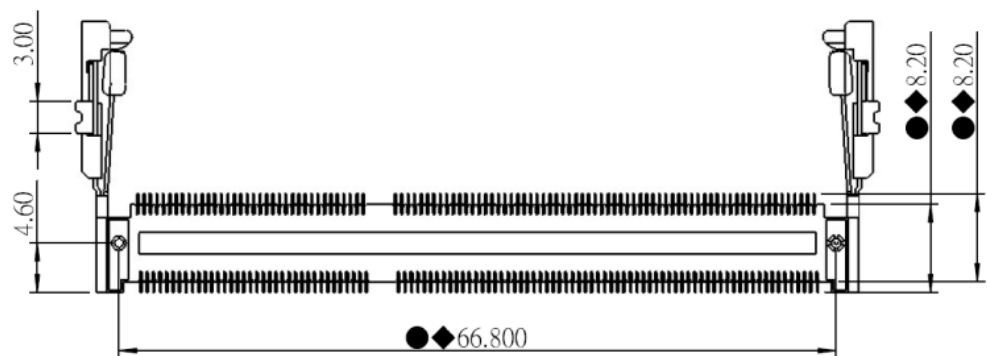
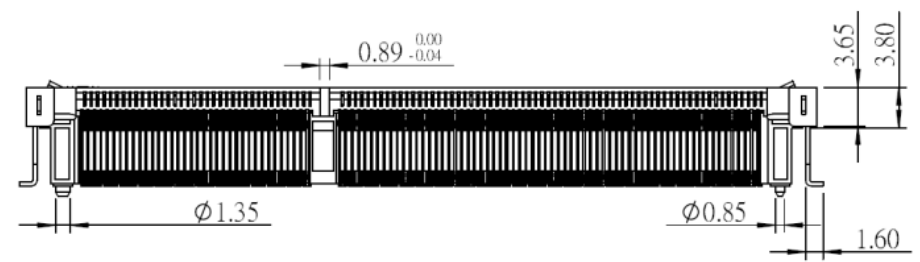
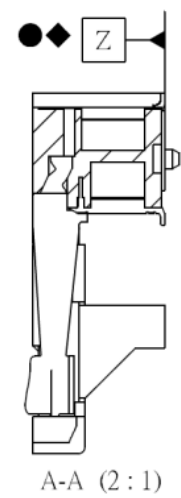

RoHS Compliant

TOLERANCES ARE

MORETHANALL
 PCB CONNECTORS
 Cable ASSEMBLIES

煜倫股份有限公司

www.morethanall.com

DRAWING BY CY		X. ± 0.30 .X ± 0.20 .XX ± 0.10 .XXX ± 0.05 ANG ±
CHECKED BY GENIUS		
UNIT / mm	SCALE 1 : 1	
DATE		
SIZE A4	P PROJECTION	

照片框

ORDER INFORMATION

SDM6-W92V15-A372-LF
 SERIES | | | LEADFREE
 | | | 132+72 WAY
 | | | 1.5V
 | | | HIGH:9.2mm
 | | | 90°SMT

DESCRIPTION:

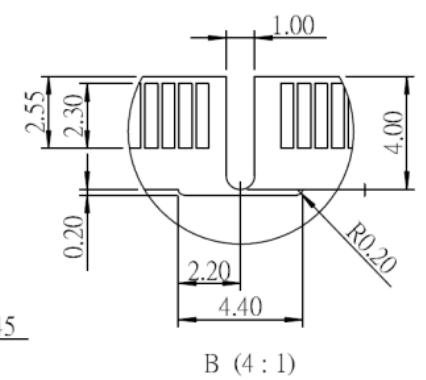
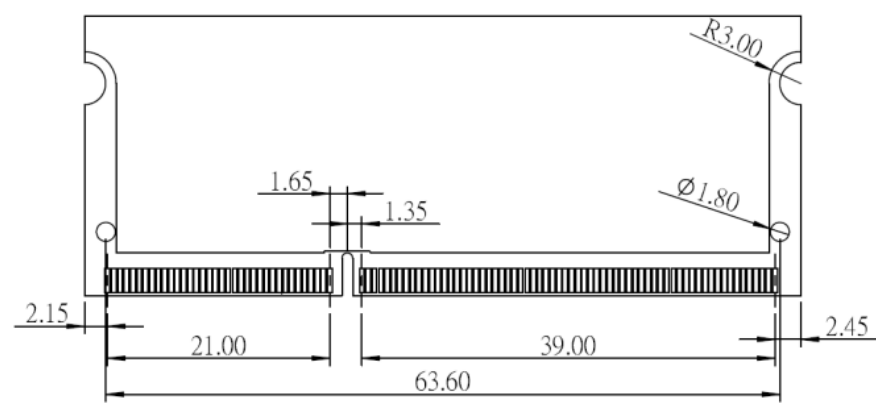
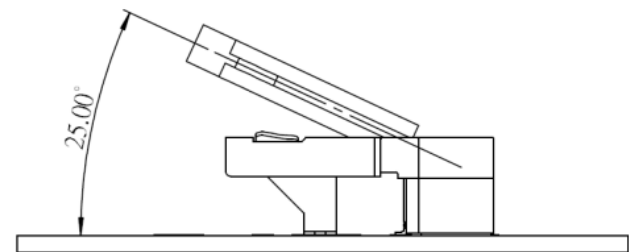
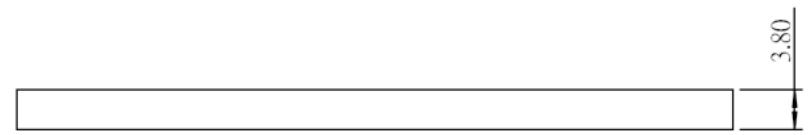
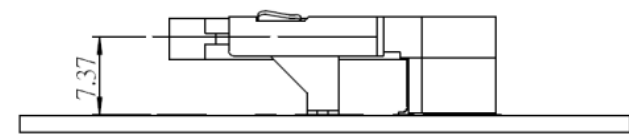
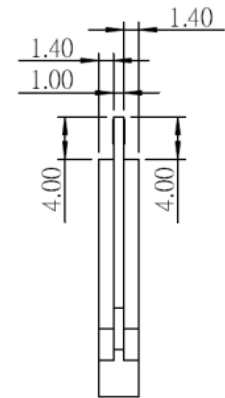
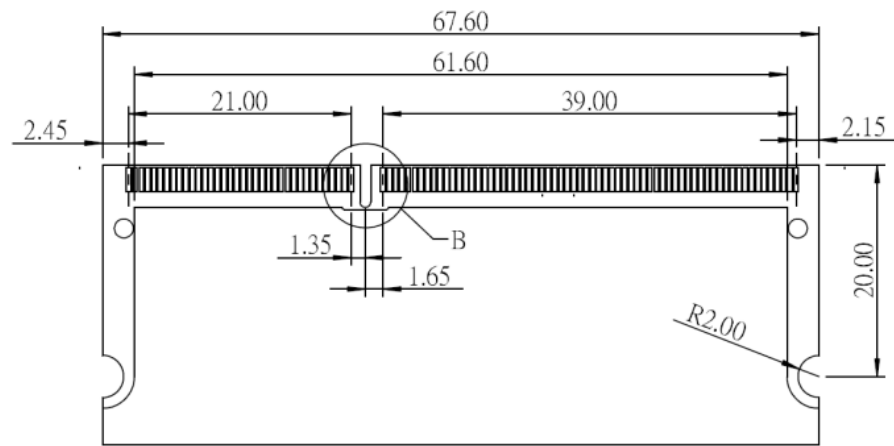

RoHS Compliant

TOLERANCES ARE

MORETHANALL
PCB CONNECTORS
Cable ASSEMBLIES

煜倫股份有限公司

www.morethanall.com

DRAWING BY CY		X. ± 0.30 .X ± 0.20 .XX ± 0.10 .XXX ± 0.05 ANG ±
CHECKED BY GENIUS		
UNIT / mm	SCALE 1 : 1	
DATE		

SIZE A4 PROJECTION

照片框

ORDER INFORMATION

SDM6-W92V15-A372-LF
SERIES | 1.5V | LEADFREE
HIGH: 9.2mm
90° SMT
132+72 WAY

DESCRIPTION:

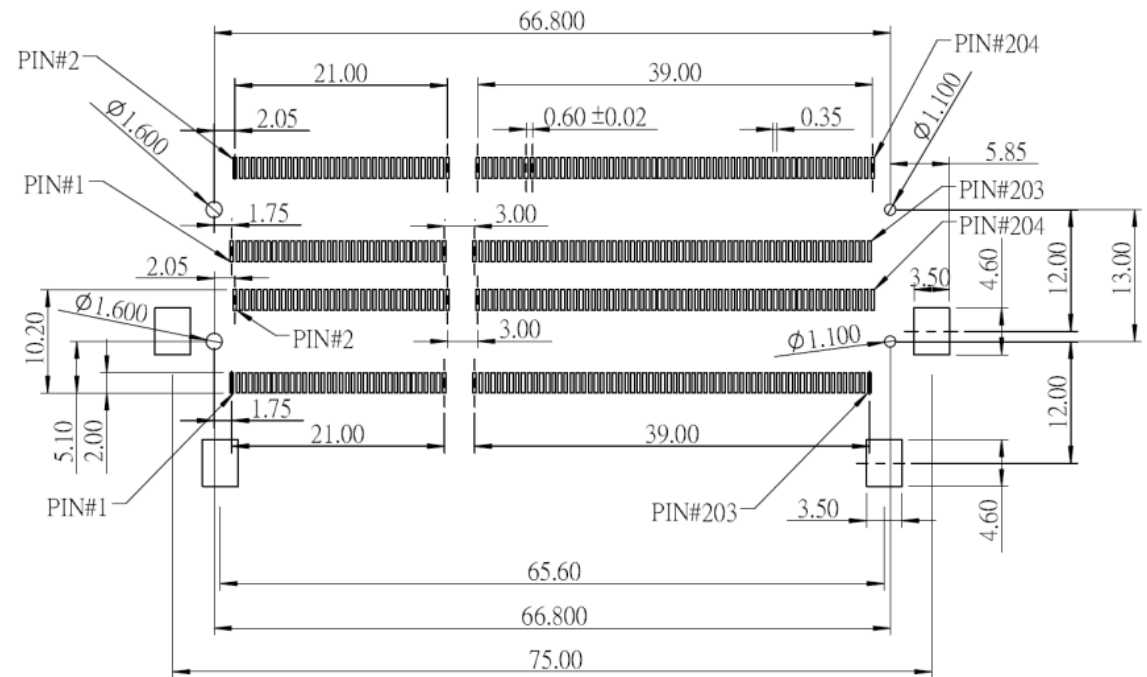
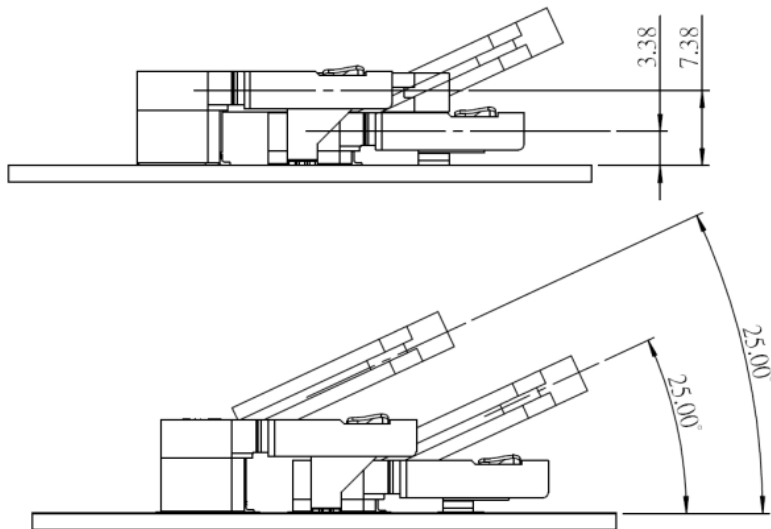

PCB LAYOUT

MORETHANALL
PCB CONNECTORS
Cable ASSEMBLIES

煜倫股份有限公司

www.morethanall.com

RoHS Compliant

DRAWING BY CY
CHECKED BY GENIUS
UNIT / mm SCALE 1 : 1
DATE
SIZE A4

TOLERANCES ARE

X. ± 0.30
.X ± 0.20
.XX ± 0.10
.XXX ± 0.05
ANG ±

P PROJECTION

照片框

ORDER INFORMATION

SDM6-W92V15-A372-LF

SERIES | LEADFREE
1.5V
HIGH: 9.2mm
90° SMT
132+72 WAY

DESCRIPTION: