

DATE CODE: 18101 (YYWW)
 YY: YEAR (2018)
 WW: WEEK (01~52)
 D: DAY (1~7)

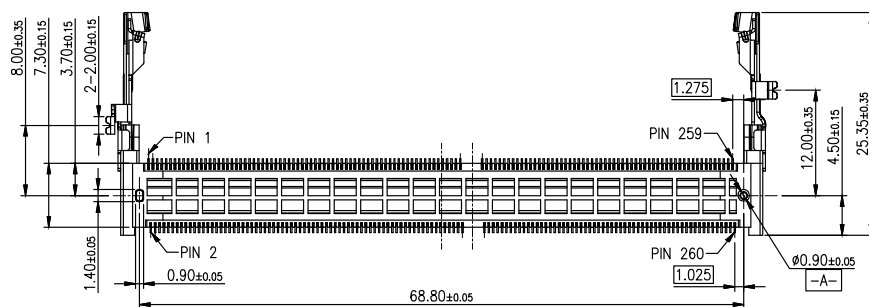
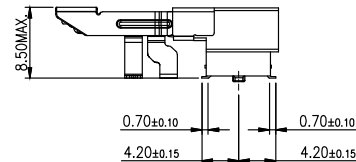
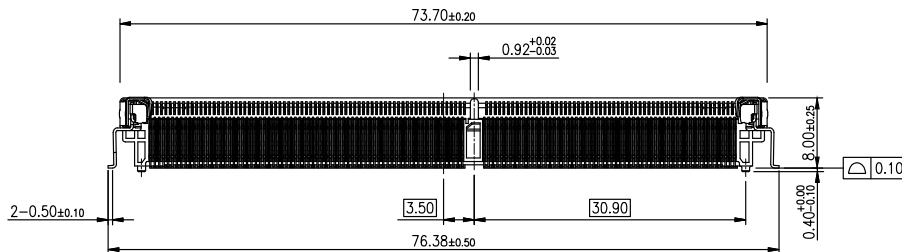
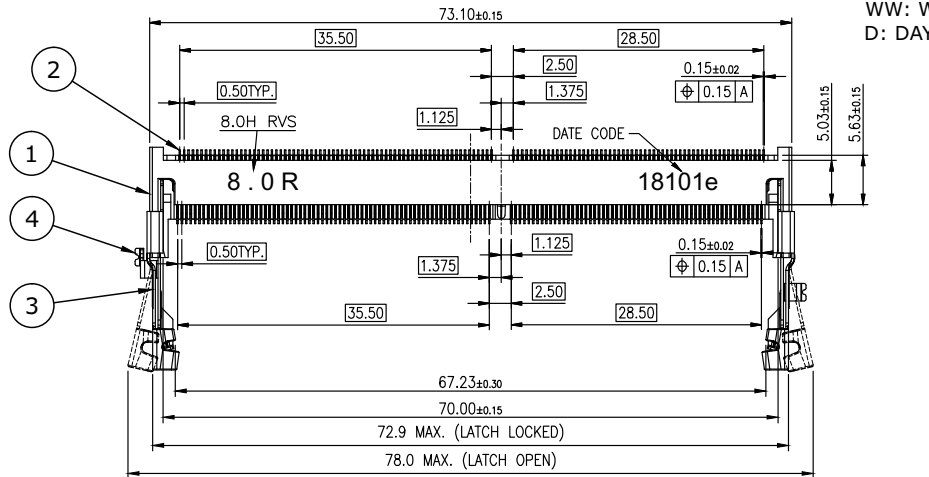

SPECIFICATION:

1. ELECTRICAL
 - 1.1 Current Rating: 0.6A per pin
 - 1.2 Voltage Rating: 25V AC
 - 1.3 Contact Resistance: 6 max.
 - 1.4 Insulation Resistance: 100M
 - 1.5 Dielectric Withstanding Voltage: 500VAC
2. MECHANICAL
 - 2.1 Durability: 50 Cycle
 - 2.2 Insertion Force: 59.8N max.
 - 2.3 Extraction Force: 44.6N max.
3. ENVIRONMENTAL
 - 3.1 Operating temperature range: -40 ~+
 - 3.2 Storage temperature range: -40 ~+
4. SOLDER ABILITY
 - 4.1 Recommended IR-Reflow Temperature: 260

NO.	PART NAME	DESCRIPTION
4	PEG	Stainless steel, 50u" min. tin plating over 50u" min. nickel plating
3	LATCH	Stainless steel
2	CONTACT	Copper alloy, contact area gold flash, solder area gold flash, under plating 50u" min. nickel
1	HOUSING	LCP, UL94V-0, black

RoHS Compliant

TOLERANCES ARE

MORETHANALL
 PCB CONNECTORS
 Cable ASSEMBLIES
 煜倫股份有限公司

DRAWING BY CY

CHECKED BY GENIUS

UNIT / mm

SCALE 1 : 1

DATE

SIZE A4

X ± 0.50
 .X ± 0.25
 .XX ± 0.12
 .XXX ±
 ANG ±

PJECTION

照片框

ORDER INFORMATION

SDM5-W80V12-116144-LF
 SERIES | 12V | LEADFREE
 | HIGH 8.0mm | 116+144 WAY
 90°SMT

DESCRIPTION: DDR4 SODIMM Socket, Horizontal 8.0H, RVS, G/F, Black, Reel, Solder PEG

www.morethanall.com

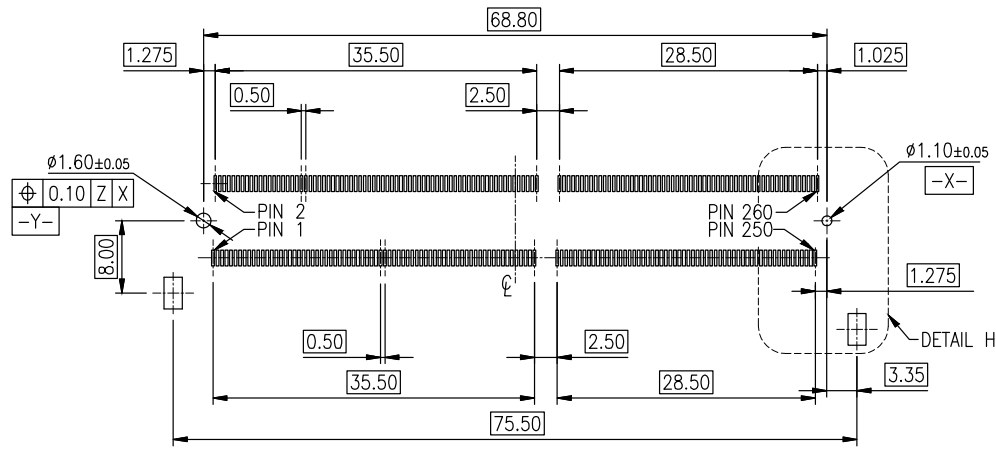

RECOMMENDED LAYOUT (TOP VIEW)

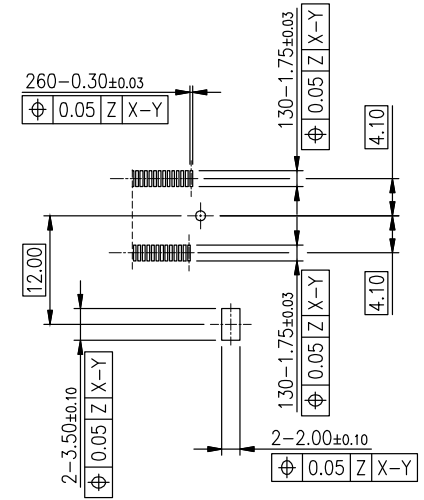

DETAIL H
SCALE 1/1

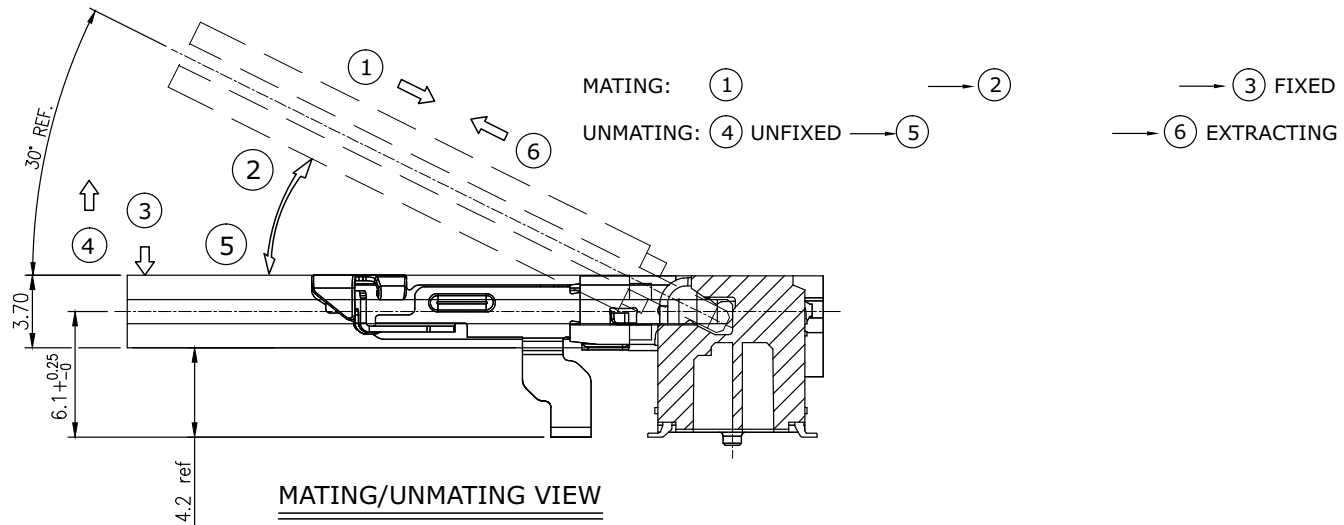

MATING/UNMATING VIEW

RoHS Compliant

TOLERANCES ARE

MORETHANALL
PCB CONNECTORS
Cable ASSEMBLIES

DRAWING BY CY

CHECKED BY GENIUS

UNIT / mm SCALE 1 : 1

DATE

SIZE A4

X. ± 0.50
.X ± 0.25
.XX ± 0.12
.XXX ±
ANG ±

PJECTION

照片框

ORDER INFORMATION

SDM5-W80V12-116144-LF

SERIES LEADFREE

12V
HIGH 8.0mm
90°SMT

116+144 WAY

煜倫股份有限公司

www.morethanall.com

DESCRIPTION: DDR4 SODIMM Socket, Horizontal 8.0H, RVS, G/F, Black, Reel, Solder PEG

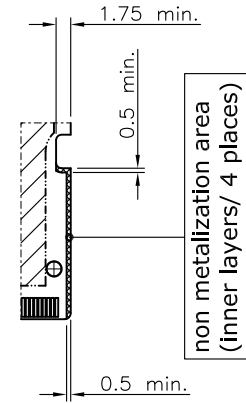
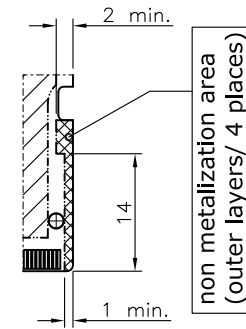
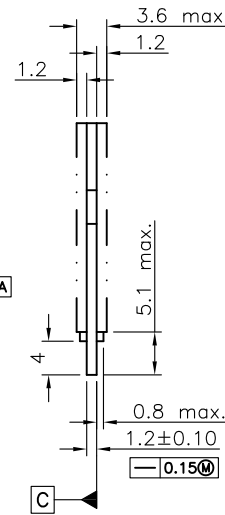
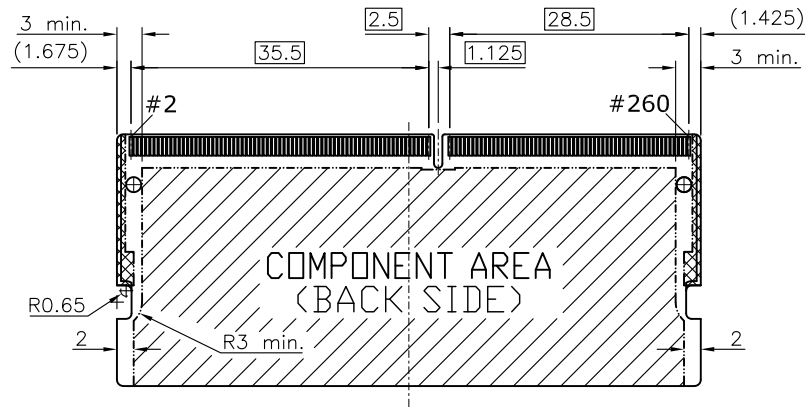
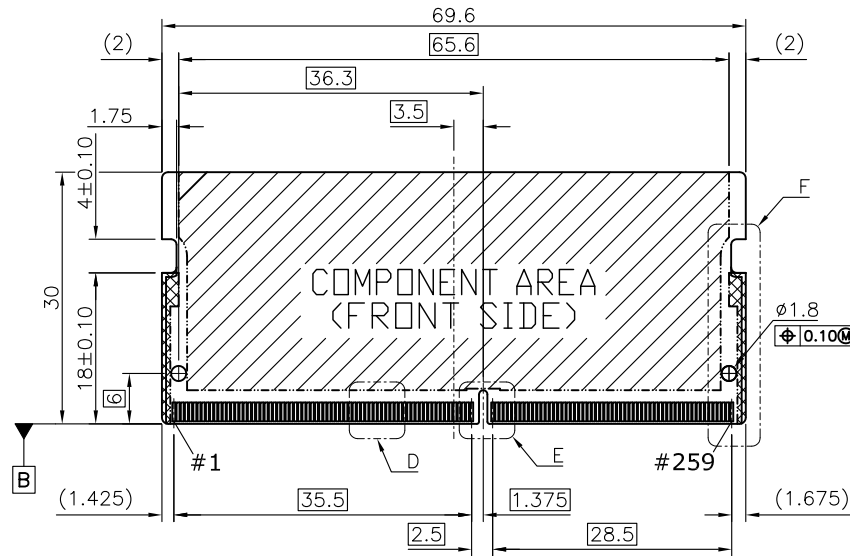

Detail F

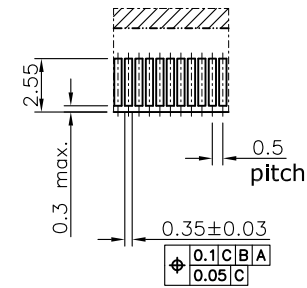

Detail D
SCALE 3.125

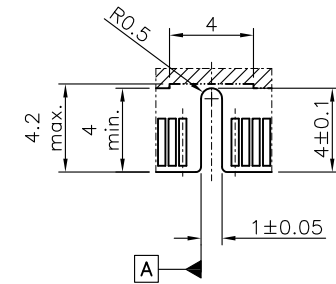

Detail E
SCALE 3.125

Note: tolerance on dimensions is ± 0.15 unless otherwise specified.

RoHS Compliant

TOLERANCES ARE

MORETHANALL
PCB CONNECTORS
Cable ASSEMBLIES

DRAWING BY CY

X. ± 0.50

CHECKED BY GENIUS

.X ± 0.25

UNIT / mm

SCALE 1 : 1

.XX ± 0.12

DATE

.XXX \pm

ANG \pm

SIZE A4

PPOJECTION

照片框

ORDER INFORMATION

SDM5-W80V12-116144-LF

SERIES

12V

HIGH 8.0mm

90°SMT

LEADFREE

116+144 WAY

煜倫股份有限公司

www.morethanall.com

DESCRIPTION: DDR4 SODIMM Socket, Horizontal 8.0H, RVS, G/F, Black, Reel, Solder PEG