

### Specifications

Current Rating: 2Amp   
 Insulation Resistance: 1000MΩ Min.  
 Dielectric Withstanding: 500V AC/DC  
 Contact Resistance: 20mΩ Max.  
 Operating Temperature: -40°C to +105°C

### Materials

Contact Material: Phosphor Bronze  
 Insulation Material: Polyester, UL 94V-0  
 Nylon 6T (Processing temp, 260°C, 10sec)

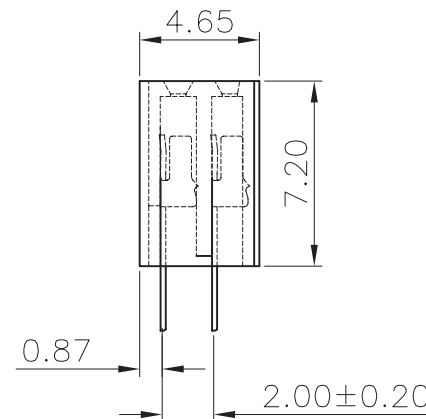
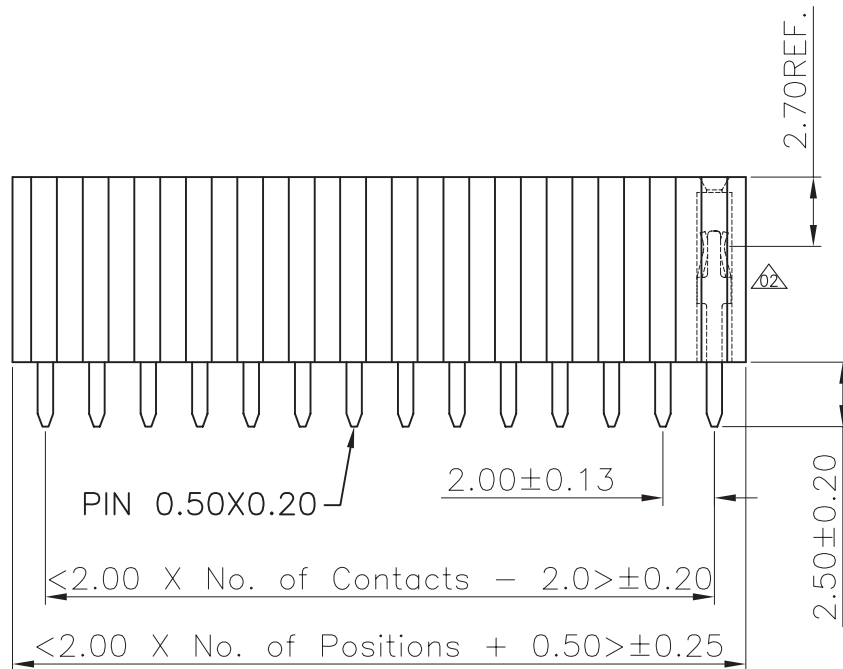
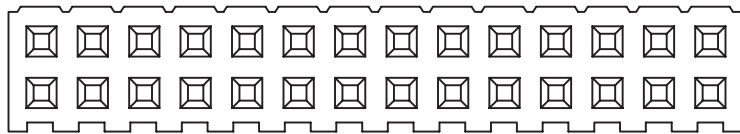

Recommended P.C.Board

Hole Layout  
 (Tolerance: ±0.05)

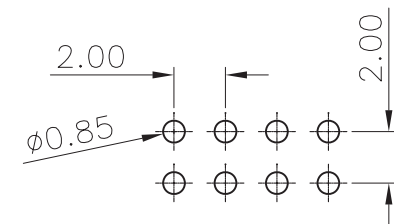

**RoHS Compliant**

TOLERANCES ARE

**MORETHANALL**  
 PCB CONNECTORS  
 Cable ASSEMBLIES

煜倫股份有限公司

www.morethanall.com

DRAWING BY CY

CHECKED BY GENIUS

UNIT/mm SCALE 1:1

DATE

SIZE A4

P PROJECTION 

X, ±  
 X, ±  
 .XX ±  
 .XXX ±  
 ANG ±

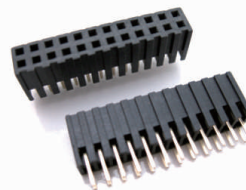

### ORDER INFORMATION

S-D72-2Xxx-LF

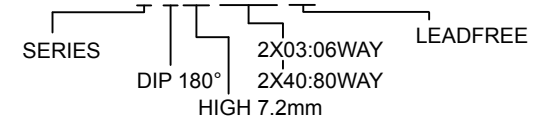

DESCRIPTION: 2.00 FEMALE HEADER DUAL ROWS DIP TYPE BASE 7.20H