

MATERIALS

HOUSING: HI-TEMP. PLASTIC (UL 94V-0), BLACK
 SHELL: COPPER ALLOY, GOLD PLATING
 TERMINAL: COPPER ALLOY, GOLD PLATED

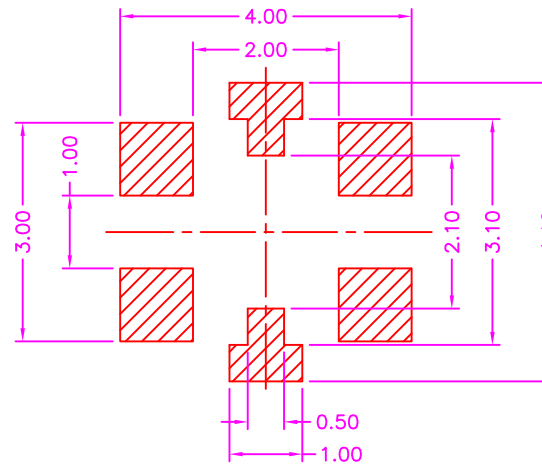

RECOMMENDED PCB LAYOUT

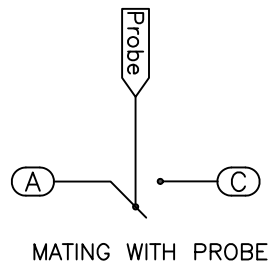
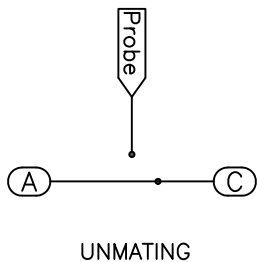
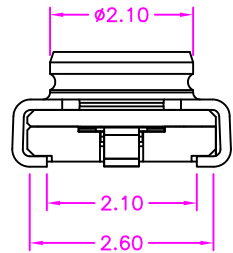
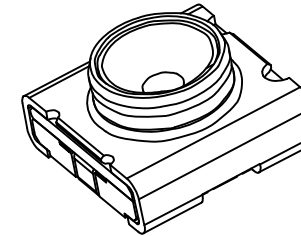
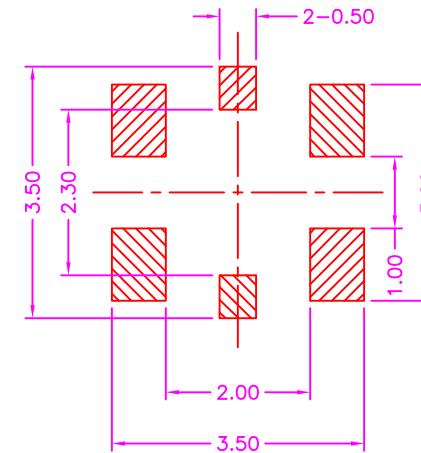

RECOMMENDED STENCIL MASK PATTERN

P.C.B. LAYOUT
 TOP VIEW ±0.05

RoHS Compliant

TOLERANCES ARE

MORETHANALL
 PCB CONNECTORS
 Cable ASSEMBLIES
 焯倫股份有限公司
 www.morethanall.com

| | | |
|-------------------|-------------|--|
| DRAWING BY CY | | X. ± 0.40 .X ± 0.30 .XX ± 0.20 .XXX ± 0.10 ANG ± |
| CHECKED BY GENIUS | | |
| UNIT / mm | SCALE 1 : 1 | |
| DATE | | |
| SIZE A4 | PJECTION | |

照片框

ORDER INFORMATION

RFS-JVR-50-LF
 SERIES | | | LEADFREE
 | | | 50 OHM
 | | | REEL
 | | | 180°SMT
 | | | JACK

DESCRIPTION: RF SWITCH (MICROWAVE SWITCH COAXIAL), SMT

PACKING DIRECTION

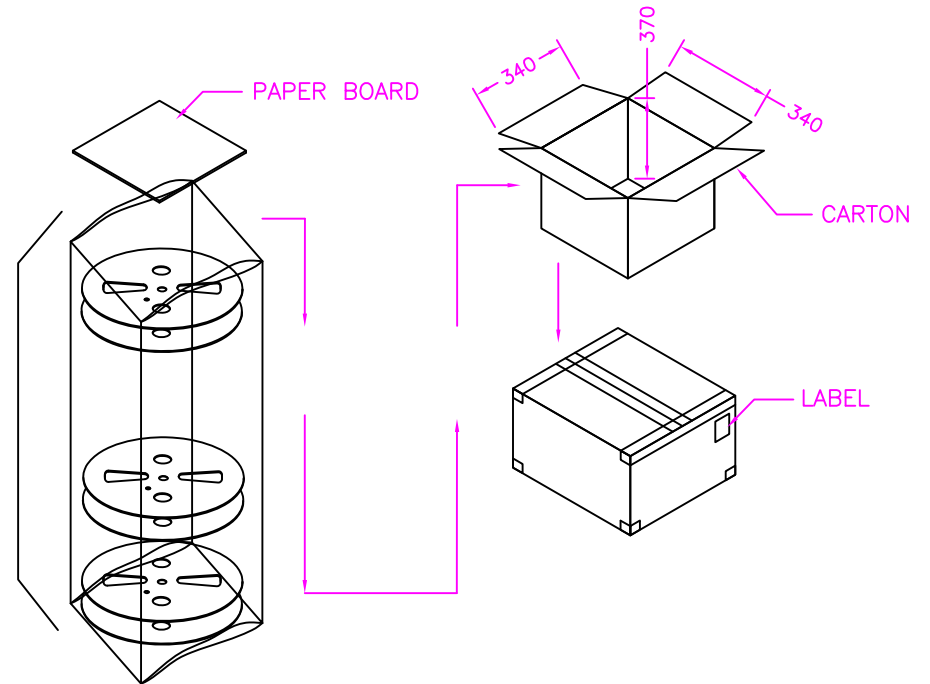
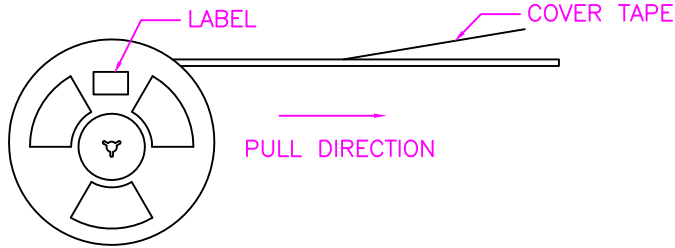
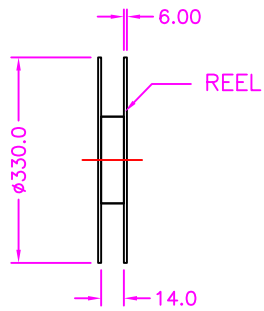
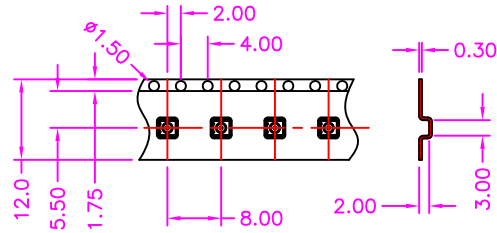
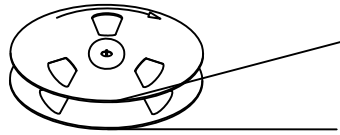

NOTE: 3500PCS/REEL, 70000PCS, 20 REEL/CARTON

RoHS Compliant

TOLERANCES ARE

MORETHANALL
PCB CONNECTORS
Cable ASSEMBLIES

DRAWING BY CY

X. ± 0.40

CHECKED BY GENIUS

.X ± 0.30

UNIT / mm

SCALE 1 : 1

.XX ± 0.20

DATE

.XXX ± 0.10

ANG \pm

照片框

ORDER INFORMATION

RFS-JVR-50-LF
SERIES | | | LEADFREE
| | | 50 OHM
| | | REEL
| | | 180°SMT
| | | JACK

煜倫股份有限公司

www.morethanall.com

SIZE A4

PJECTION

DESCRIPTION: RF SWITCH (MICROWAVE SWITCH COAXIAL), SMT