

ITEM NO.	WIRE RANGE(mm ²)	SURFACE TREATMENT	MARKING	W1	H1	W2	H2
Q02520-MT-22	0.13~0.33 mm ² 26~22 A.W.G.	Pre-Tin		2.4	2.3	2.0	1.8

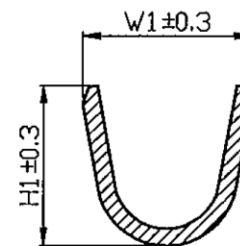

SECTION A-A
S=10/1

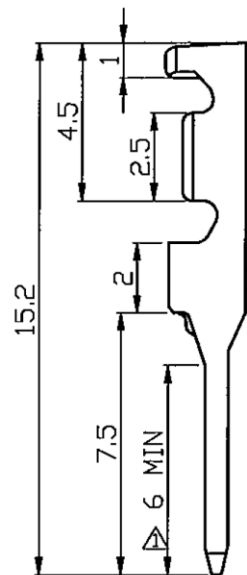
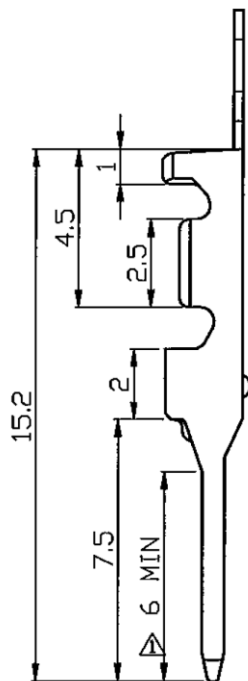
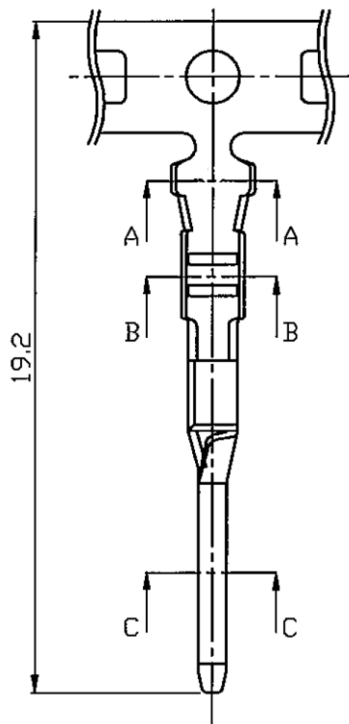
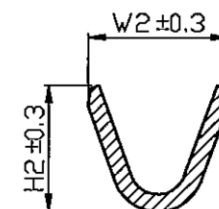

SECTION B-B
S=10/1

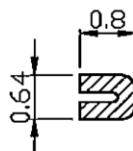
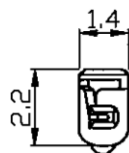

SECTION C-C
S=10/1

NOTE :
1. THICKNESS : 0.25 mm

照片框

RoHS Compliant

TOLERANCES ARE

MORETHANALL
PCB CONNECTORS
Cable ASSEMBLIES

DRAWING BY CY

CHECKED BY GENIUS

UNIT / mm

SCALE 1 : 1

DATE

SIZE A4

PJECTION

X. ±
.X ±
.XX ±
.XXX ±
ANG ±

ORDER INFORMATION

Q02520-MT-22-LF

SERIES

LEADFREE

22~26 AWG

MALE TERMINAL

煜倫股份有限公司

www.morethanall.com

DESCRIPTION: