

NOTE:  
1. ALL THE DIMENSIONS ARE MEASURED UNDER GRADE "B" UNLESS OTHERWISE SPECIFIED.

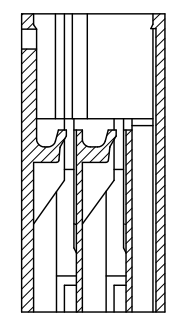

SEC: A-A

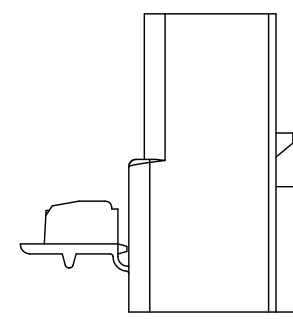
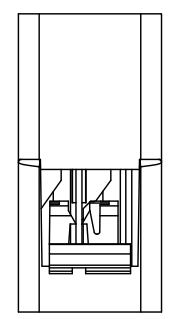
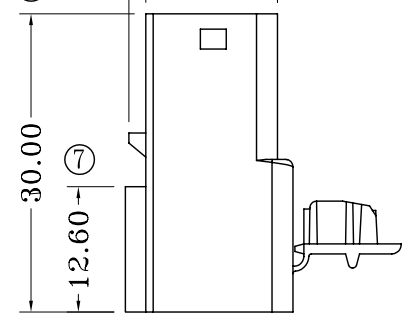
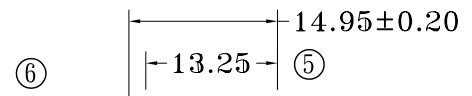
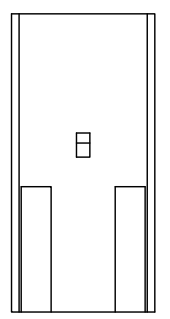
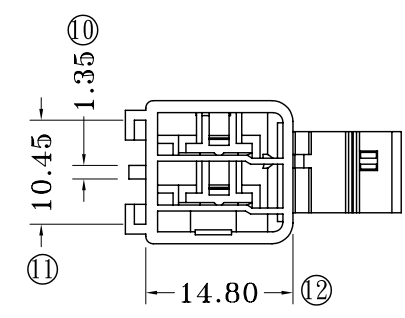
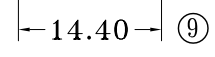
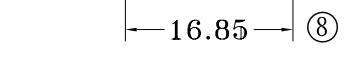

Q205-PH-02-LF  
LEADFREE

RoHS Compliant

**M** MORETHANALL  
CONNECTORS  
ASSEMBLIES

PART NO. Q205-PH-02

DWG NO. Q205-PH-02

CHECKED BY CY

TOLERANCES ARE

DESCRIP TION:

FILE NO.

DRAWING BY

.X ± 0.2  
.XX ±  
.XXX ±  
AWG

煜倫股份有限公司

UNIT / mm

SCALE 1:1

PROJECTION

AREA

REVISIONS

HK

DATE