

NOTES:

1. MATERIAL:

- HOUSING: THERMOPLASTIC, W/15% G/F, UL94 V-0, BLACK COLR
- BOTTOM COVER: THERMOPLASTIC, W/30% G/F UL94 V-0, BLACK COLOR
- RETAINER: THERMOPLASTIC, W/15% G/F, UL94 V-0, BLACK COLR
- SHUTTER: THERMOPLASTIC, W/15% G/F, UL94 V-0, BLACK COLR
- CONTACTS: PHOSPHOR BRONZE
- FRONT SHIELD: BRASS
- BACK SHIELD: BRASS
- COIL SPRING: STAINLESS STEEL
- GROUINDING TAB: STAINLESS STEEL
- DRIVE IC (TRANSMITTER)/TX
- DRIVE IC LEAD FRAME: PHOSPHOR BRONZE

2. FINISH:

- CONTACT:
 - GOLD FLASH PLATING ON CONTACT AREA.
 - 100 μ " MIN. BRIGHT TIN PLATING ON SOLDER TAIL AREA,
 - 50 μ " MIN. NICKEL UNDERPLATING OVERALL.
- BACK SHIELD:
 - 100 μ " MIN. NICKEL PLATING CN ENTIRE
 - 50 μ " MIN. Cu UNDERPLATING OVERALL
- FRONT SHIELD:
 - 100 μ " MIN. TIN PLATING ON ENTIRE
 - 50 μ " MIN. NICKEL UNDERPLATING OVERALL
- LEADFRAME:
 - 100 μ " MIN. TIN PLATING ON ENTIRE
 - 50 μ " MIN. NICKEL UNDERPLATING OVERALL

3. RECOMMENDED PCB THICKNESS: 1.6mm

TRANSMITTER	
Vin	①
Vcc	②
GND	③

RoHS Compliant

TOLERANCES ARE

MORETHANALL
PCB CONNECTORS
Cable ASSEMBLIES

DRAWING BY CY

X. \pm

CHECKED BY GENIUS

.X \pm

UNIT / mm

SCALE 1 : 1

.XX \pm

DATE

.XXX \pm

ANG \pm

SIZE A4

PJECTION

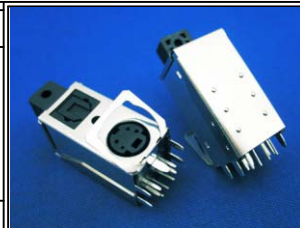

ORDER INFORMATION

POFMD-FTHS-0304-LF

SERIES

LEADFREE

03 TO 04 WAY

SPRING

TOP HOLE

FEMALE

煜倫股份有限公司

www.morethanall.com

DESCRIPTION: MINI DIN 4 POS. WITH SPDIF CONNECT

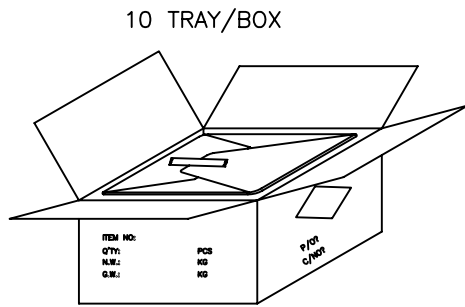

10 TRAY/BOX

SHOPPING CARTON

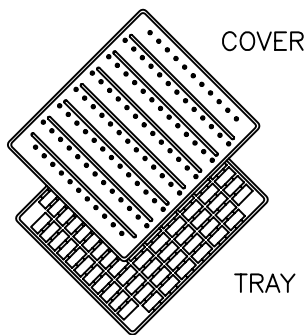

COVER

TRAY

100PCS/TRAY

NOTES:

1. PACKAGE DIMENSION :
 - a. TRAY:(L)353*(W)275*(H)24
 - b. SHOPPING CARTON:(L)370*(W)290*(H)265
2. PACKAGE MATERIAL:
 - a. TRAY:PS
 - b. COVER:PS
3. PACKAGE DETAIL:
 - a. 100 PCS/TRAY
 - b. 10 TRAYS/SHOPPING CARTON(1,000 PCS)
4. WEIGHT DETAIL:
 - a. NET Wt=10.2kg
 - b. GROSS Wt=11.7kg

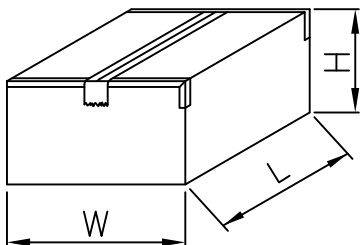
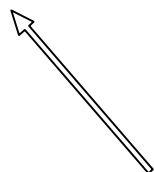

10 TRAY/BOX

SHOPPING CARTON

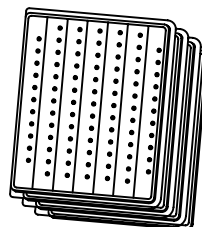

10 TRAY

RoHS Compliant

TOLERANCES ARE

MORETHANALL
PCB CONNECTORS
Cable ASSEMBLIES

DRAWING BY CY

CHECKED BY GENIUS

UNIT / mm

SCALE 1:1

DATE

SIZE A4

PPOJECTION

X. ±
.X ±
.XX ±
.XXX ±
ANG ±

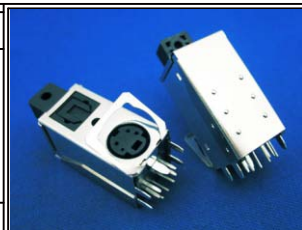

ORDER INFORMATION

POFMD-FTHS-0304-LF

SERIES	LEADFREE
	03 TO 04 WAY
	SPRING
	TOP HOLE
	FEMALE

DESCRIPTION: MINI DIN 4 POS. WITH SPDIF CONNECT

煜倫股份有限公司

www.morethanall.com