

NOTE:

1. MATERIAL AND FINISH

1.1. SHELL ASSEMBLY: COPPER ALLOY, OUTER SHELL AND COLLET
NUT Cr PLATING, OTHER METALLIC COMPONENTS Ni PLATING

1.2. INSULATOR: PEEK

1.3. CONTACT: COPPER ALLOY, GOLD PLATING

2. RoHS COMPLIANCE

| No. OF CONTACTS | φA | L |
|-----------------------|-----|-----|
| 02,03,04,05,06,07, | 0.7 | 3.0 |
| 08,10,12,14,16,18,19, | 0.7 | 3.0 |
| 26,32, | 0.5 | 3.0 |

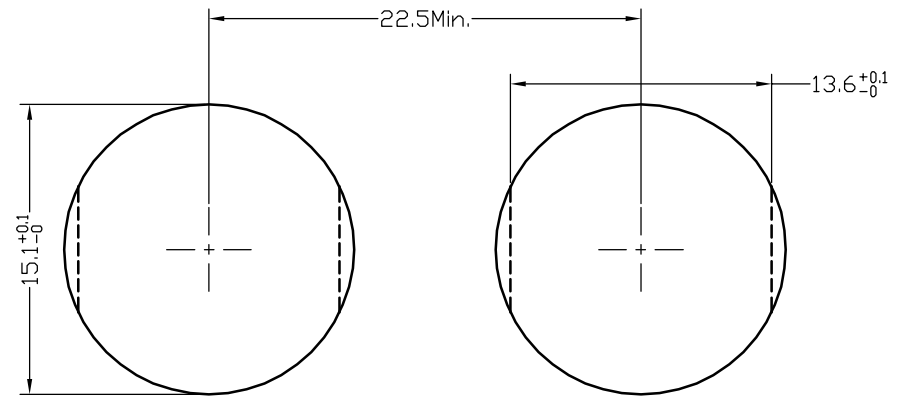

PANEL CUT-OUT

RoHS Compliant

TOLERANCES ARE

MORETHANALL
PCB CONNECTORS
Cable ASSEMBLIES

煜倫股份有限公司

www.morethanall.com

DRAWING BY CY

CHECKED BY GENIUS

UNIT / mm

SCALE 1:1

DATE

SIZE A4

X, ±
.X ± 0.50
.XX ± 0.30
.XXX ± 0.10
ANG ± 2°

P PROJECTION

照片框

ORDER INFORMATION

PM16-SSPANW-xy-LF
SERIES | | | | LEADFREE
| | | | 0-Z KEY
| | | | 02-32 WAY
| | | | NUT+WASHER
FEMALE | | | | PANEL FRONT
SOLDER

DESCRIPTION:

2B FIXED SOCKET SOLDER CONTACT TYPE VIEW

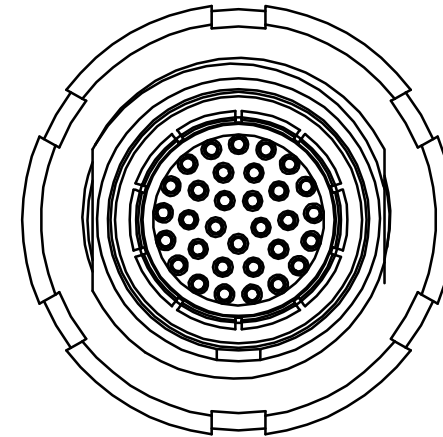
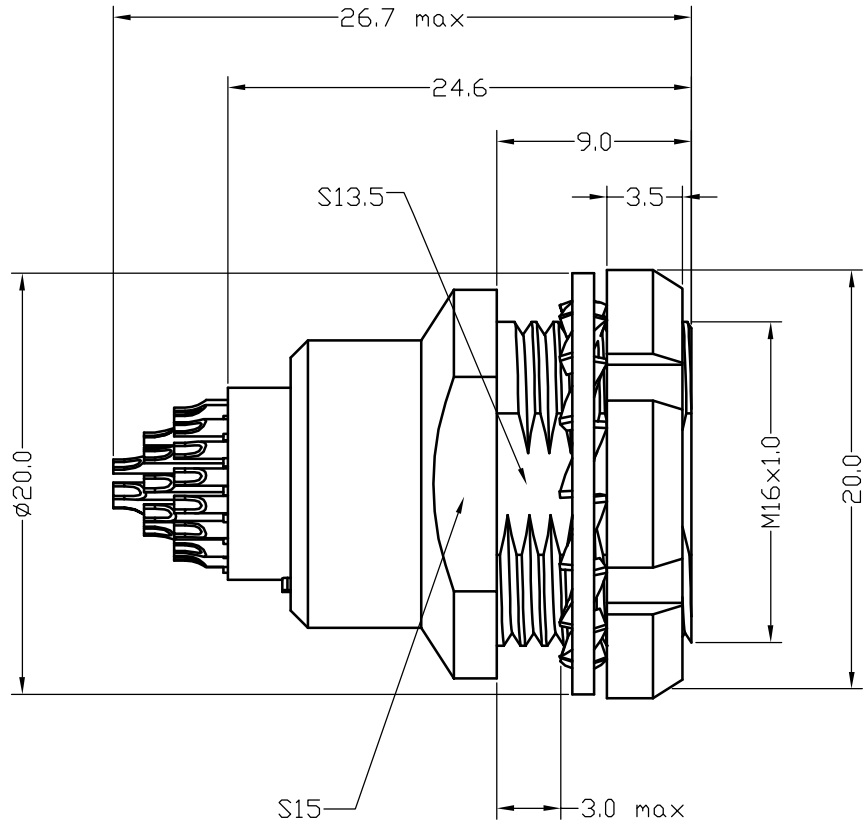

RoHS Compliant

TOLERANCES ARE

MORETHANALL
PCB CONNECTORS
Cable ASSEMBLIES

DRAWING BY CY

CHECKED BY GENIUS

UNIT / mm SCALE 1:1

DATE

SIZE A4

X, ±
.X ± 0.50
.XX ± 0.30
.XXX ± 0.10
ANG ± 2°

P PROJECTION

照片框

ORDER INFORMATION

PM16-SSPANW-xyy-LF

SERIES | | | | LEADFREE
| | | | 0-Z KEY
| | | | 02-32 WAY
| | | | NUT+WASHER
FEMALE | | | | PANEL FRONT
SOLDER

煜倫股份有限公司

www.morethanall.com

DESCRIPTION:

view from termination side pin part

2 PDS.

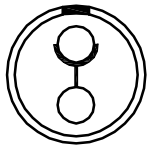

3 PDS.

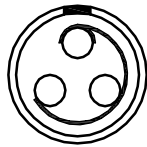

4 PDS.

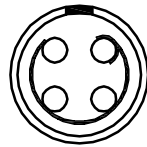

5 PDS.

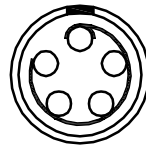

6 PDS.

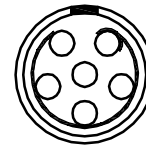

7 PDS.

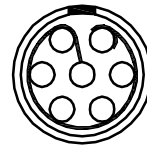

8 PDS.

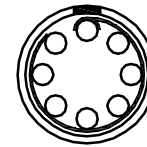

10 PDS.

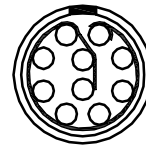

12 PDS.

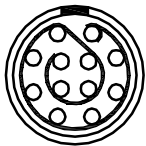

14 PDS.

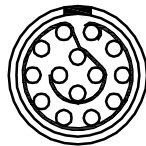

16 PDS.

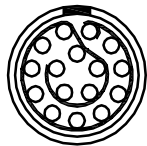

18 PDS.

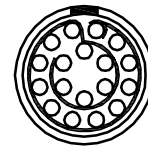

19 PDS.

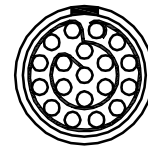

26 PDS.

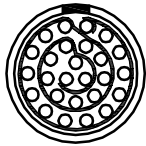

32 PDS.

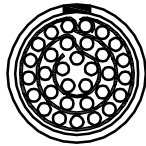

RoHS Compliant

TOLERANCES ARE

MORETHANALL
PCB CONNECTORS
Cable ASSEMBLIES

DRAWING BY CY

CHECKED BY GENIUS

UNIT / mm

SCALE 1:1

DATE

SIZE A4

X, ±
.X ± 0.50
.XX ± 0.30
.XXX ± 0.10
ANG ± 2°

PPOJECTION

照片框

ORDER INFORMATION

PM16-SSPANW-xy-LF

SERIES

FEMALE

SOLDER

LEADFREE

0-Z KEY

02-32 WAY

NUT+WASHER

PANEL FRONT

煜倫股份有限公司

www.morethanall.com

DESCRIPTION:

KEY ANGLES (RECEPTACLE FRONT VIEW):

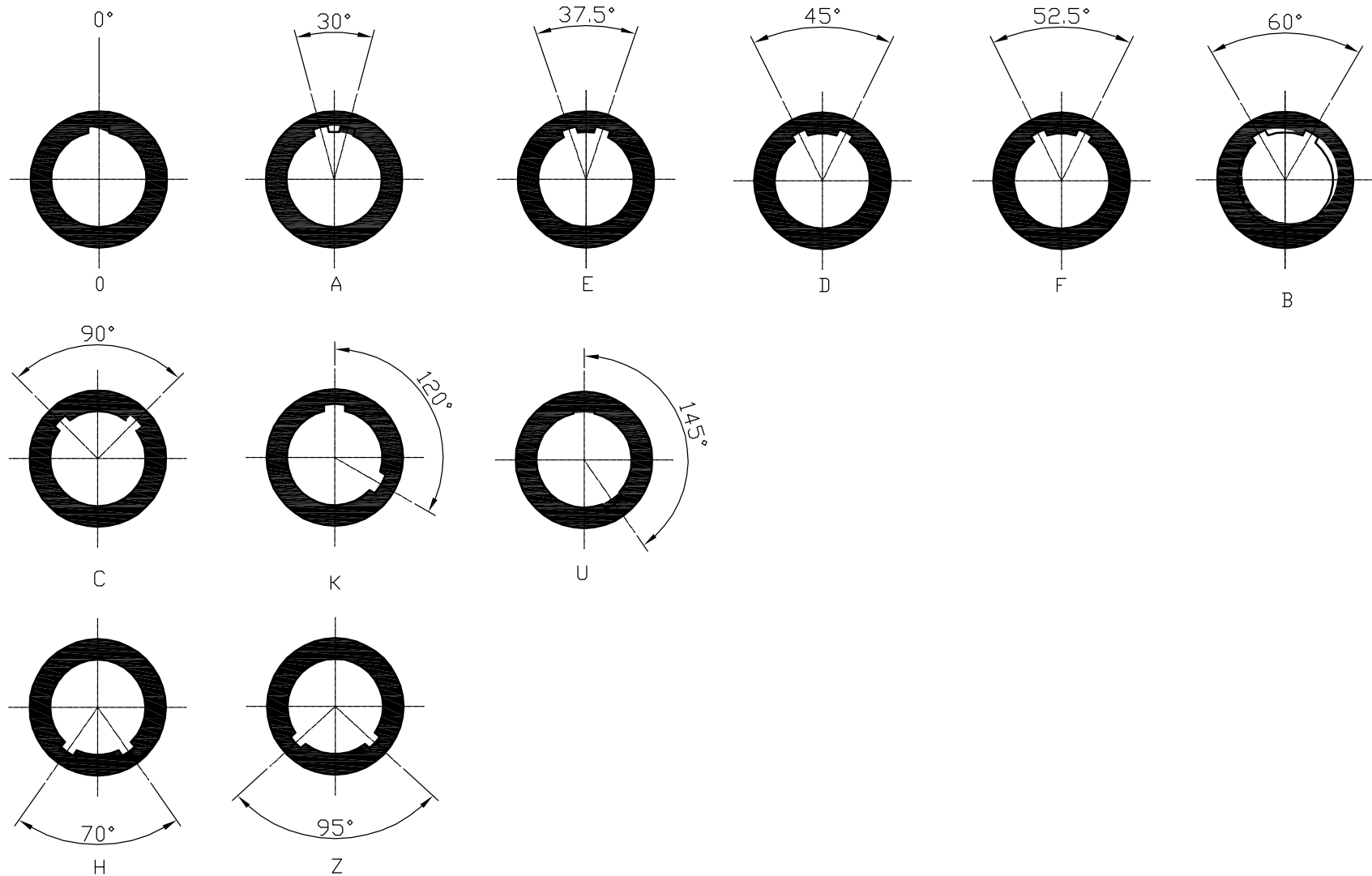

RoHS Compliant

TOLERANCES ARE

MORETHANALL
PCB CONNECTORS
Cable ASSEMBLIES

DRAWING BY CY

CHECKED BY GENIUS

UNIT / mm

SCALE 1:1

DATE

SIZE A4

X, ±
.X ± 0.50
.XX ± 0.30
.XXX ± 0.10
ANG ± 2°

PJECTION

照片框

ORDER INFORMATION

PM16-SSPANW-xy-LF
SERIES | | | LEADFREE
| | | 0-Z KEY
| | | 02-32 WAY
| | | NUT+WASHER
FEMALE | | PANEL FRONT
SOLDER

煜倫股份有限公司

www.morethanall.com

DESCRIPTION:

PCB Drilling Pattern

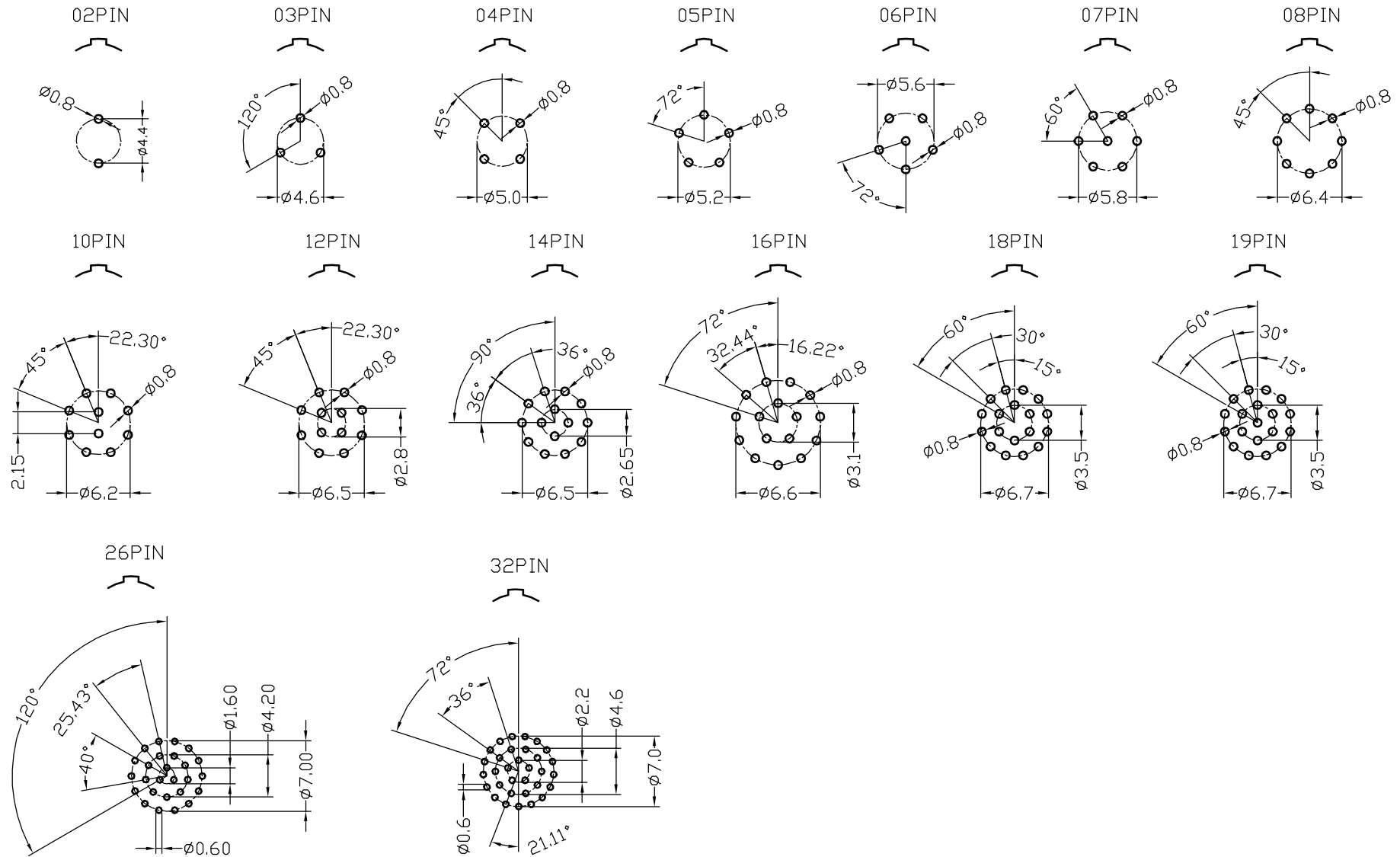

RoHS Compliant

TOLERANCES ARE

MORETHANALL
PCB CONNECTORS
Cable ASSEMBLIES

DRAWING BY CY
CHECKED BY GENIUS
UNIT / mm SCALE 1 : 1
DATE

X, ±
.X ± 0.50
.XX ± 0.30
.XXX ± 0.10
ANG ± 2°

照片框

ORDER INFORMATION

PM16-SSPANW-xy-LF
SERIES | | | LEADFREE
| | | 0-Z KEY
| | | 02-32 WAY
| | | NUT+WASHER
FEMALE | | PANEL FRONT
SOLDER

煜倫股份有限公司

www.morethanall.com

SIZE A4 PPROJECTION

DESCRIPTION: