

A-A SEC.

DIM.A = 0.50 * No. of Spaces
 DIM.B = DIM.A + 5.0
 DIM.C = DIM.A + 2.0
 DIM.D = DIM.A + 2.5

△ * Available in 10 through 80 circuits

Material:

- * Insulation:
Glass filled Polyamide UL 94V-0
Color Black
- * Contact: Copper alloy, t=0.2mm
- * Fixed Tab: Brass, t=0.2mm

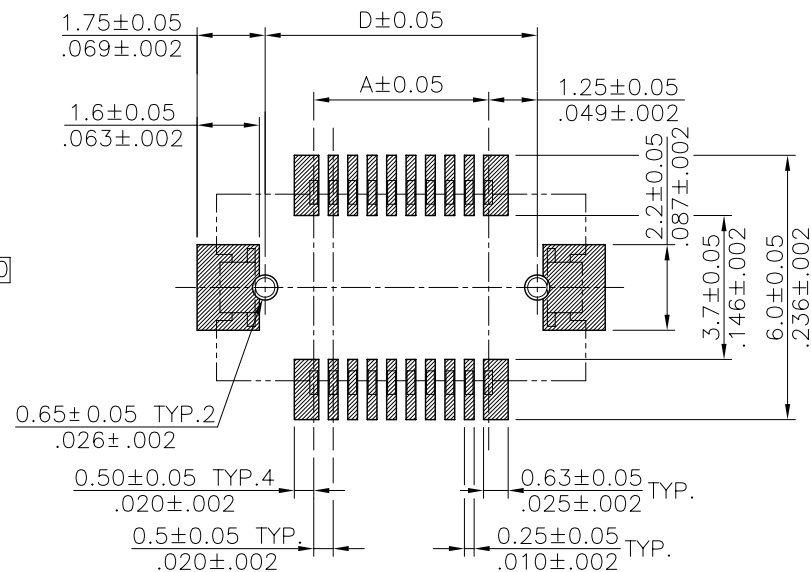

Recommended P.C. Board Layout

RoHS Compliant

TOLERANCES ARE

MORETHANALL
 PCB CONNECTORS
 Cable ASSEMBLIES

DRAWING BY CY

X.±

CHECKED BY GENIUS

.X±

UNIT / mm

SCALE 1:1

.XX±

DATE

.XXX±

ANG±

煜倫股份有限公司

www.morethanall.com

SIZE A4

PJECTION

照片框

ORDER INFORMATION

NP0527-PxxPR-xxx-LF

SERIES

LEADFREE

MALE



REEL

POST

25:UNMATED HIGH 2.5mm

50:UNMATED HIGH 5.0mm

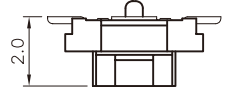
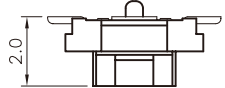
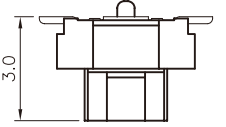
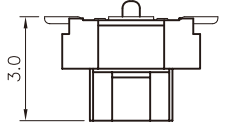
DESCRIPTION:

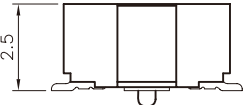
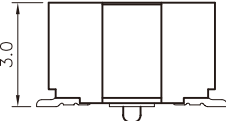
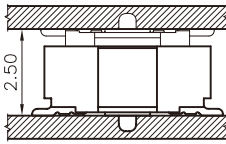
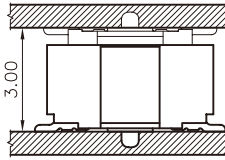
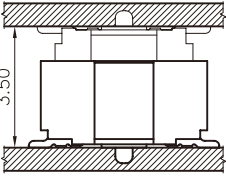
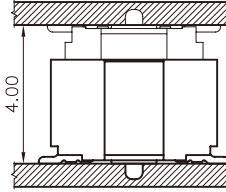
Female	NP0526-S05PR-xxx 	NP0526-S05PR-xxx 	NP0526-S10PR-xxx 	NP0526-S10PR-xxx 
Male	NP0526-P20PR-xxx 	NP0526-P25PR-xxx 		NP0526-P30PR-xxx 
Mating Height	 2.50	 3.00	 3.50	 4.00

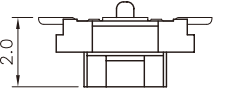
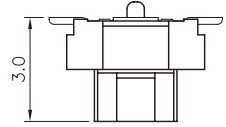
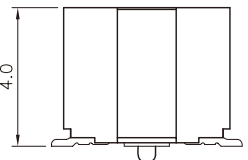
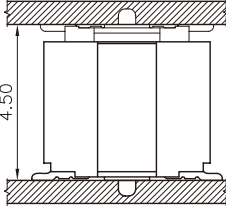
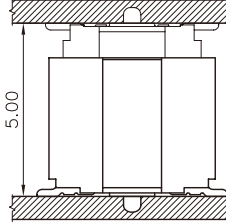
Female	NP0526-S05PR-xxx 	NP0526-S10PR-xxx 
Male	NP0526-P40PR-xxx 	
Mating Height	 4.50	 5.00



煜倫股份有限公司

www.morethanall.com

RoHS Compliant

DRAWING BY CY
CHECKED BY GENIUS
UNIT / mm SCALE 1:1
DATE

TOLERANCES ARE

X. ±
.X ±
.XX ±
.XXX ±
ANG ±

SIZE A4

PJECTION 

照片框

ORDER INFORMATION

NP0527-PxxPR-xxx-LF

SERIES | | | | LEADFREE
010-080WAY
MALE | | | | REEL
POST
25:UNMATED HIGH 2.5mm
50:UNMATED HIGH 5.0mm

DESCRIPTION:

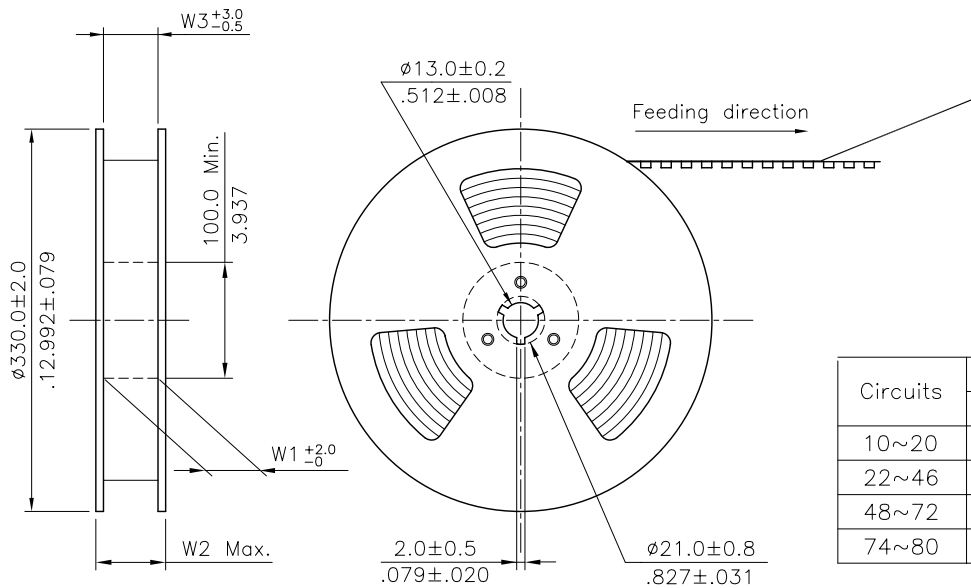

NOTE :

- * Reel Material : HIPS
- * Carrier Material : Clear, Conductive Polystyrene Alloy
- * Cover Tape Material : Polyester
- * Cover Tape Peel Strength : 0.1N – 1.3N
- * Carrier camber is within 1mm in 100mm
- * All dimensions meet EIA-481-2 & EIA-481-3 requirements.
- * Quantity : 1000 PCS/Reel

Circuits	Dimension					Packing (Reel/Caton)
	E	F	W1	W2	W3	
10~20	16.0(.630)	-	16.5(.650)	22.5(.886)	16.5(.650)	11
22~46	24.0(.945)	-	24.5(.965)	30.5(1.200)	24.5(.965)	9
48~72	32.0(1.260)	28.40(1.118)	32.5(1.280)	38.5(1.516)	32.5(1.280)	7
74~80	44.0(1.732)	40.40(1.591)	44.5(1.752)	50.5(1.988)	44.5(1.752)	5

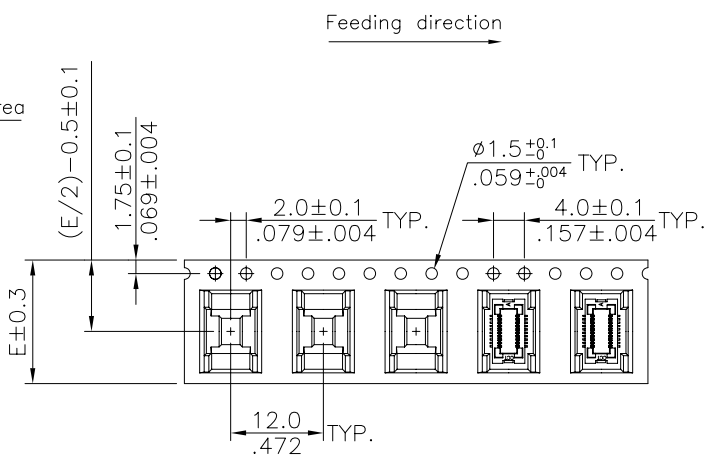
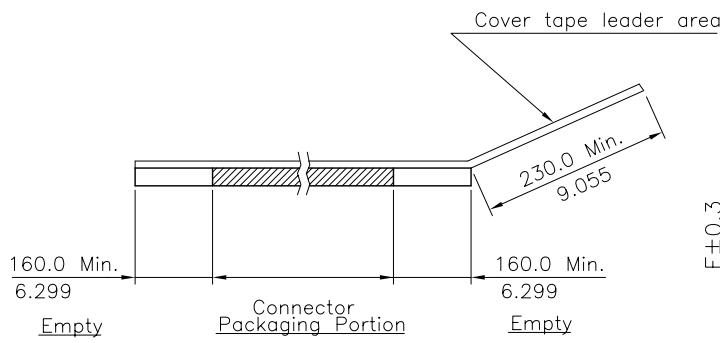

WIDTH : 16,24 mm Carrier

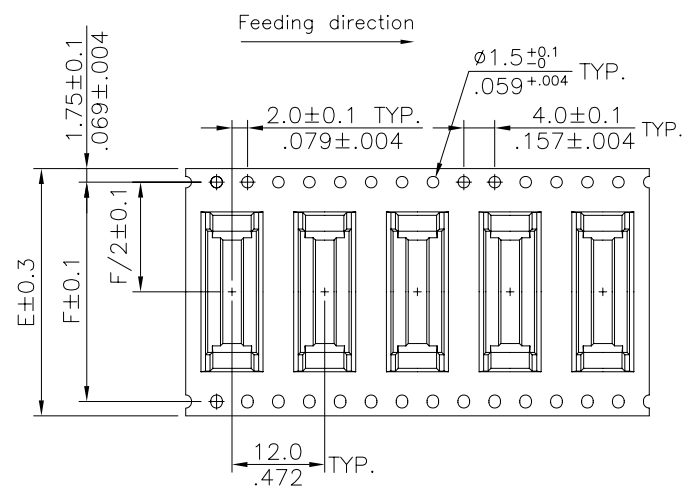

WIDTH : 32 mm Carrier

RoHS Compliant

TOLERANCES ARE

MORETHANALL
PCB CONNECTORS
Cable ASSEMBLIES
煜倫股份有限公司
www.morethanall.com

DRAWING BY CY		X. ± .X ± .XX ± .XXX ± ANG ±
CHECKED BY GENIUS		
UNIT / mm	SCALE 1 : 1	
DATE		
SIZE A4	PJECTION	



ORDER INFORMATION

NP0527-PxxPR-xxx-LF
SERIES | | | LEADFREE
MALE | | | REEL | | | 010-080WAY
POST
25:UNMATED HIGH 2.5mm
50:UNMATED HIGH 5.0mm

DESCRIPTION: