

NOTES:

1. MATERIAL:
HOUSING: HIGH TEMPERATURE THERMO PLASTIC UL94V-0
TERMINAL: COPPER ALLOY
SOLDER PEG: COPPER ALLOY
2. FINISH:
TERMINAL:
CONTACT AREA: SEE CHARTS
SOLDERING AREA: SEE CHARTS
UNDER PL.: NICKEL PL. 50μ THK MIN.
3. THIS PRODUCT DOESN'T CONTAIN ENVIRONMENTAL HAZARDOUS PER DIRECTIVE 2002/95/EC FOR RoHS COMPLIANT.

RoHS Compliant

TOLERANCES ARE

MORETHANALL
PCB CONNECTORS
Cable ASSEMBLIES

DRAWING BY CY

CHECKED BY GENIUS

UNIT / mm

SCALE 1:1

DATE

SIZE A4

PJECTION

X, \pm
.X \pm
.XX \pm
.XXX \pm
ANG \pm

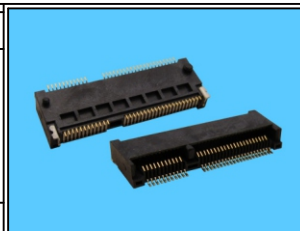

ORDER INFORMATION

NGFF-W32-2344-LF

SERIES | LEADFREE
23+44 WAY
HIGH 3.2mm
90°SMT

煜倫股份有限公司

www.morethanall.com

DESCRIPTION:

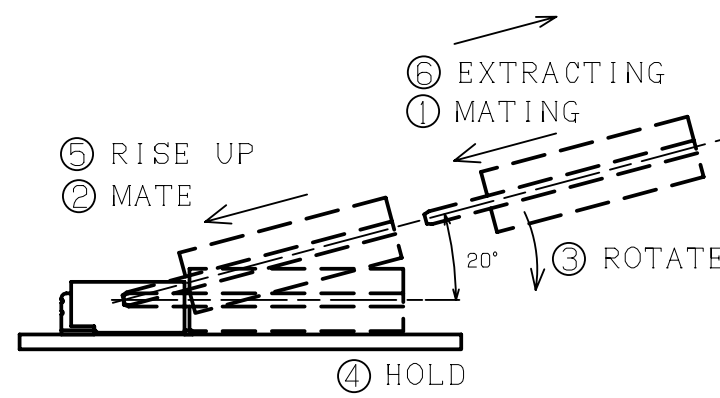
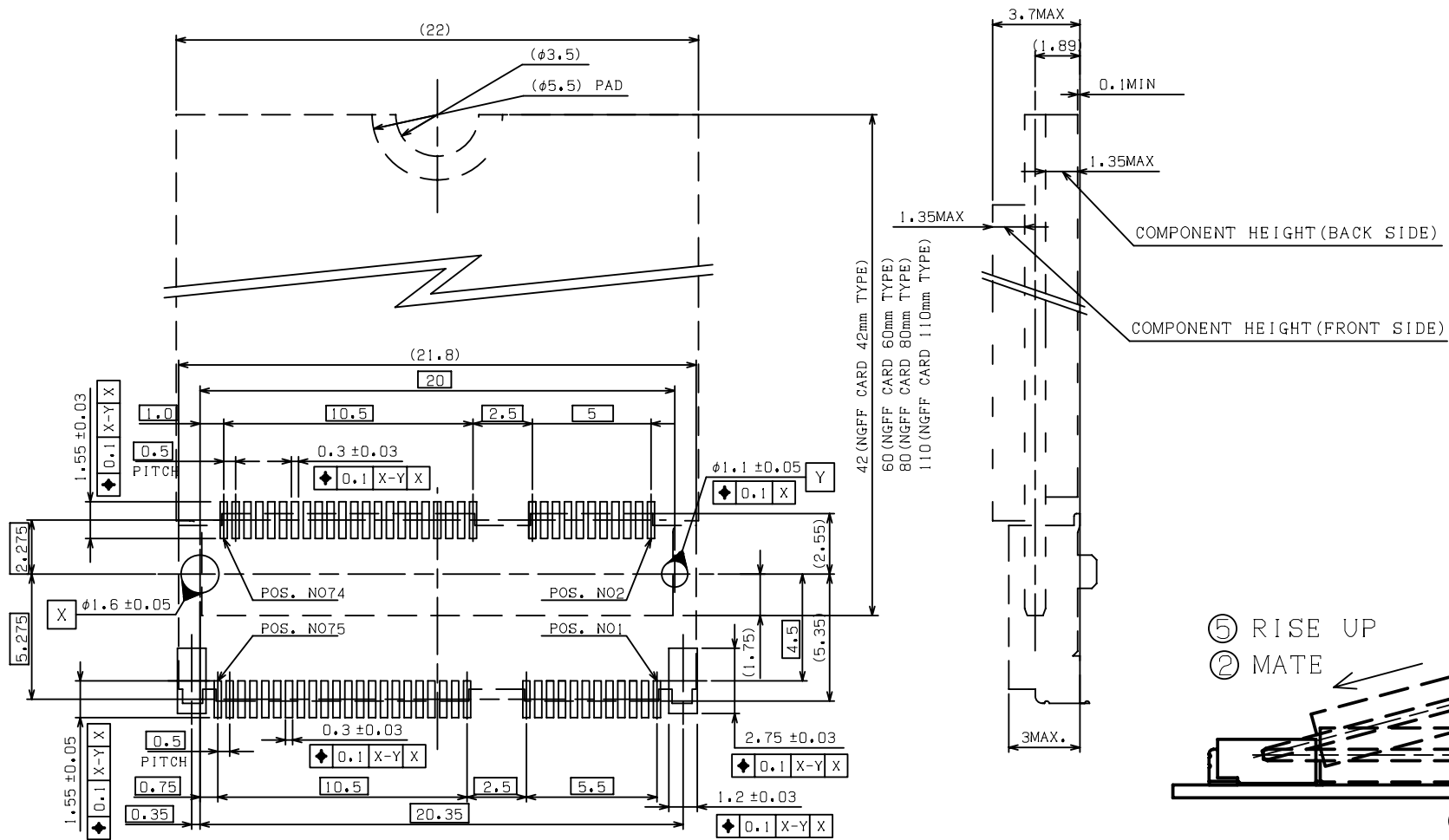

KEY ID "E"
RECOMMENDED P.C. BOARD LAYOUT

RoHS Compliant

TOLERANCES ARE

X, \pm
.X \pm
.XX \pm
.XXX \pm
ANG \pm

DRAWING BY CY

CHECKED BY GENIUS

UNIT / mm

SCALE 1:1

DATE

SIZE A4

PJECTION

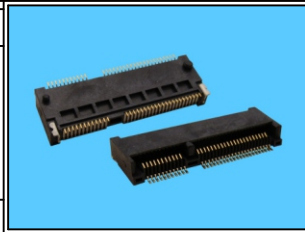

ORDER INFORMATION

NGFF-W32-2344-LF

SERIES | LEADFREE
23+44 WAY
HIGH 3.2mm
90°SMT

DESCRIPTION:

MORETHANALL
PCB CONNECTORS
Cable ASSEMBLIES

煜倫股份有限公司

www.morethanall.com

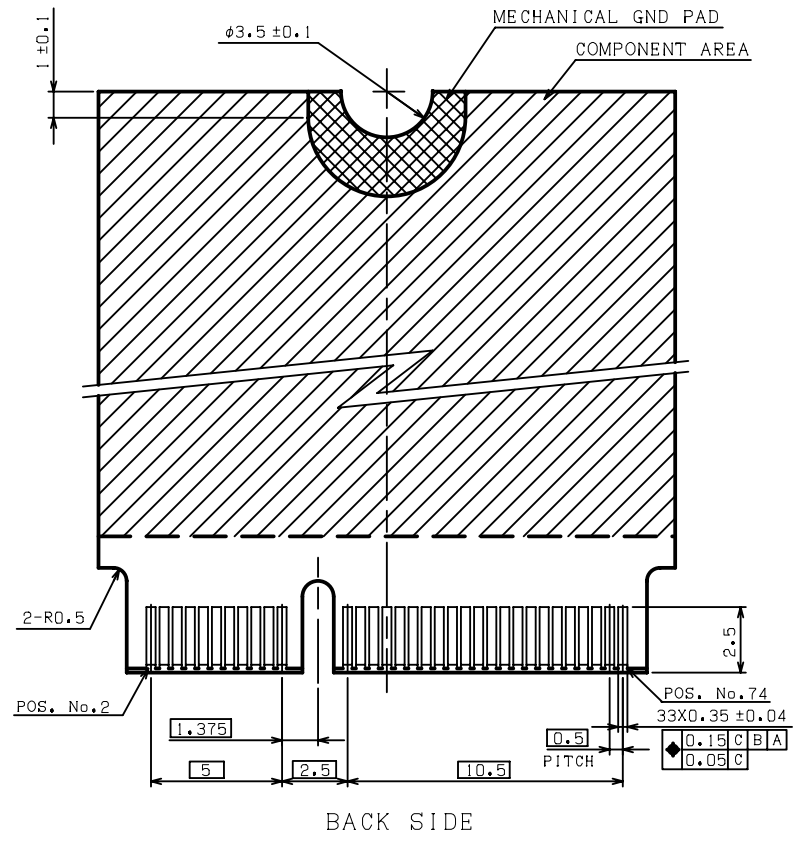
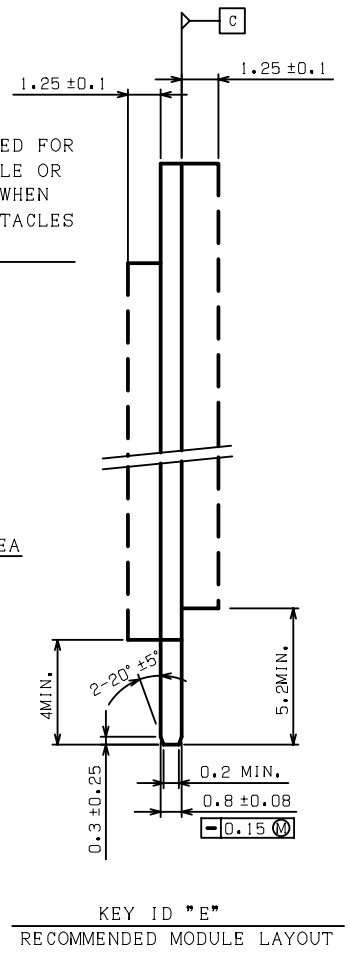
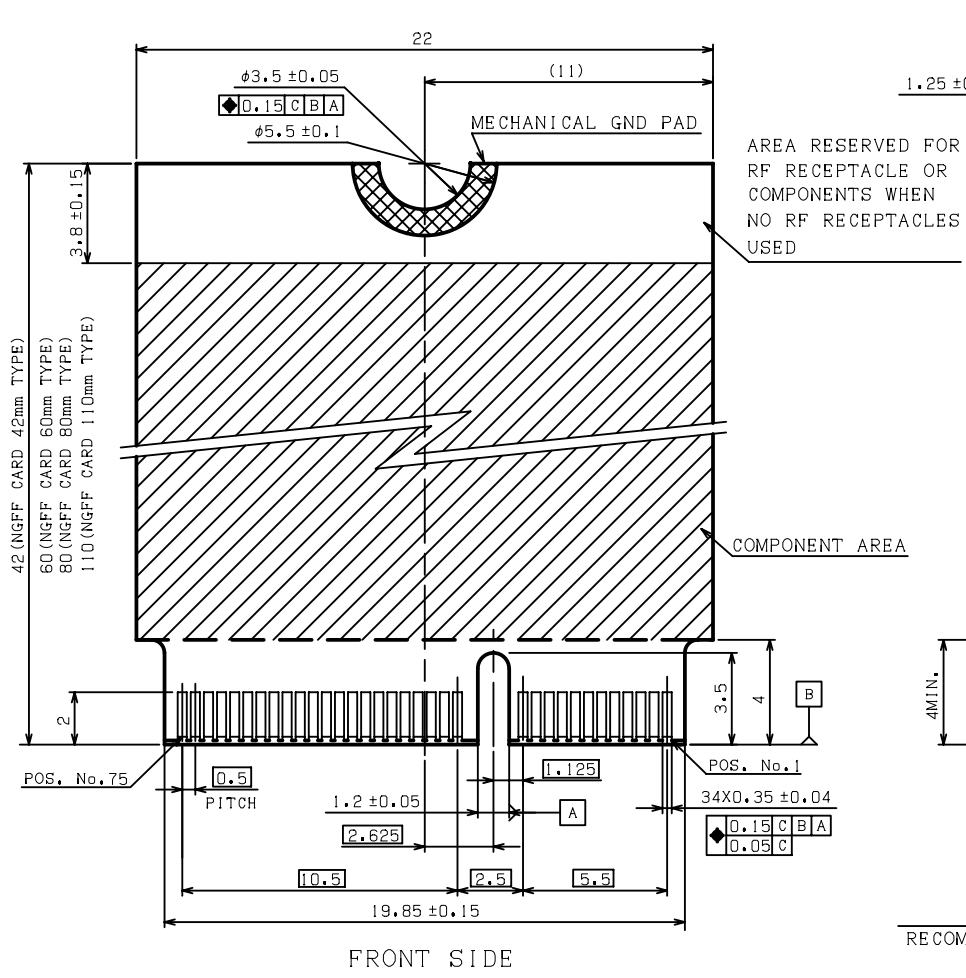

RoHS Compliant

TOLERANCES ARE

MORETHANALL
PCB CONNECTORS
Cable ASSEMBLIES

DRAWING BY CY

X ±

CHECKED BY GENIUS

.X ±

UNIT / mm

SCALE 1 : 1

.XX ±

DATE

.XXX ±

SIZE A4

PJECTION

ANG ±

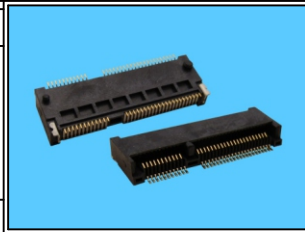

ORDER INFORMATION

NGFF-W32-2344-LF

SERIES | LEADFREE
23+44 WAY
HIGH 3.2mm
90°SMT

煜倫股份有限公司

www.morethanall.com

DESCRIPTION: