

Specifications:
 Current rating:4.0A AC,DC
 Voltage rating:250V AC, DC
 Contact testance:10m ohm Max
 Insulation resistance:1000M ohm Min
 Withstanding voltage:AC 1500V AC/minute
 Operating Temperature:-40°C ~ +105°C

Materials:
 Insulator:High Temp Plastic (LCP UL94V-0)
 Insulator Color:White&Black
 Terminal:Brass
 Finish:Tin Plated

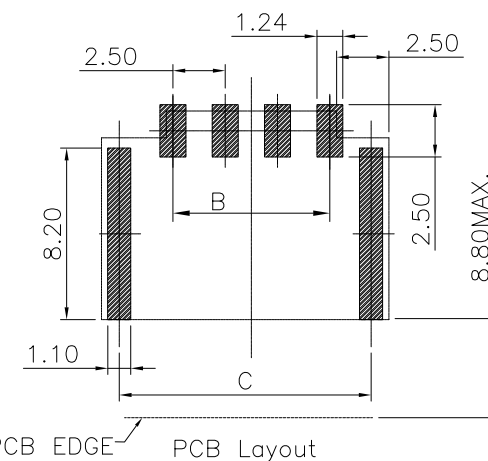
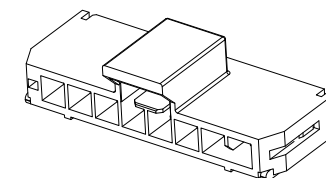
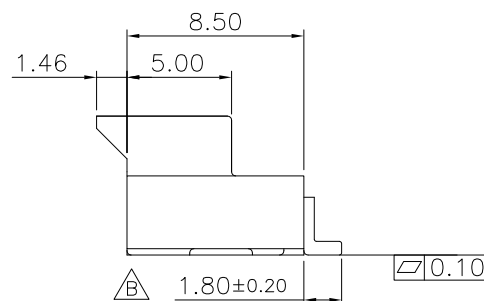
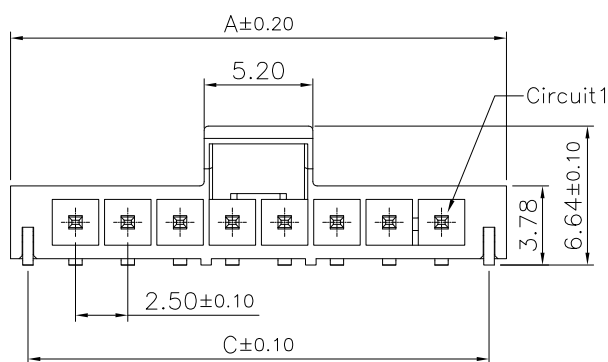

Circuits	Dimension			Circuits	Dimension		
	A	B	C		A	B	C
2	8.74	2.5	7.04	06	18.74	12.50	17.04
3	11.24	5.0	9.54	07	21.24	15.00	19.54
4	13.74	7.5	12.04	08	23.74	17.50	22.04
5	16.24	10.0	14.54				

RoHS Compliant

TOLERANCES ARE

MORETHANALL
 PCB CONNECTORS
 Cable ASSEMBLIES

煜倫股份有限公司

www.morethanall.com

DRAWING BY CY

CHECKED BY GENIUS

UNIT / mm

SCALE 1:1

DATE

SIZE A4

PJECTION

X ±
 .X ± 0.20
 .XX ± 0.15
 .XXX ±
 ANG ±

照片框

ORDER INFORMATION

NF-PWEcc-1Xxx-LF
 SERIES LEADFREE
 MALE 90°SMT BK:BLACK WH:WHITE METAL EAR
 1X02:02WAY
 1X08:08WAY

DESCRIPTION: 2.5mm Power Wafer Right Angle Type

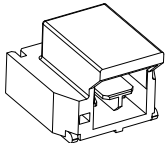
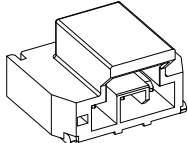
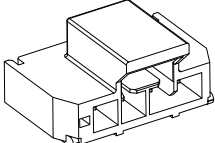
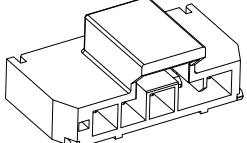
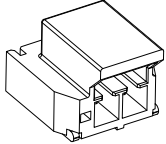
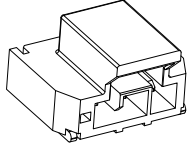
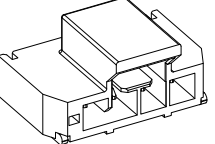
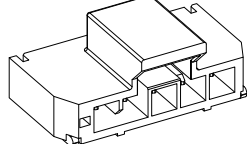
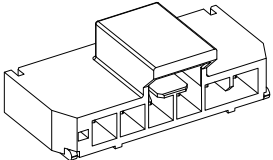
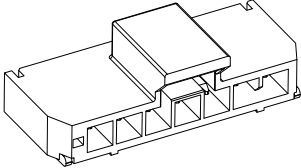
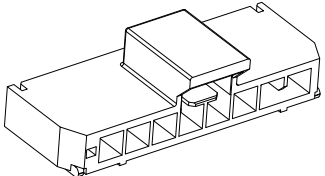
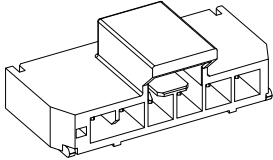
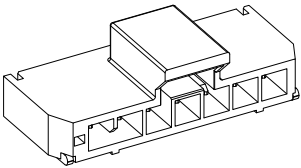
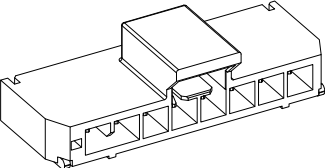
	2P	3P	4P	5P
BLACK				
NATURAL				
	6P	7P	8P	
BLACK				
NATURAL				

RoHS Compliant

TOLERANCES ARE

MORETHANALL
PCB CONNECTORS
Cable ASSEMBLIES

煜倫股份有限公司

www.morethanall.com

DRAWING BY CY

CHECKED BY GENIUS

UNIT / mm SCALE 1 : 1

DATE

SIZE A4

X: ±
.X ± 0.20
.XX ± 0.15
.XXX ±
ANG ±

PJECTION 

照片框

ORDER INFORMATION

NF-PWEcc-1Xxx-LF
SERIES | LEADFREE
1X02:02WAY
1X08:08WAY
MALE | BK:BLACK
90°SMT | WH:WHITE
METAL EAR

DESCRIPTION: 2.5mm Power Wafer Right Angle Type