

RIGHT ANGLE
BACK COVER

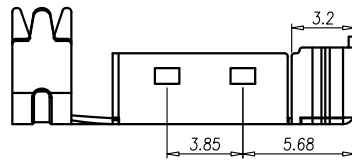

FRONT SHELL

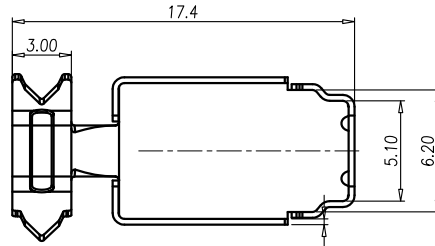
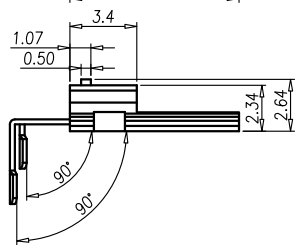
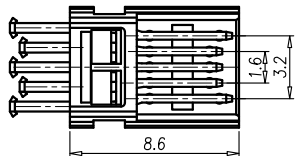
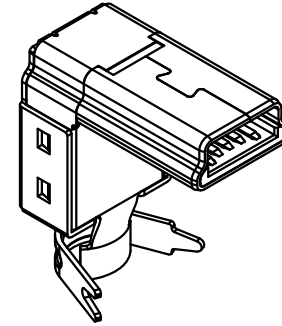
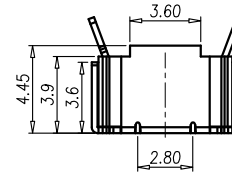

HOUSING+PIN

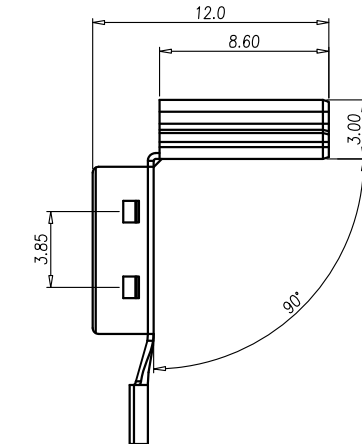
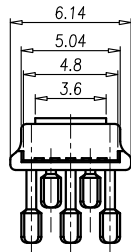
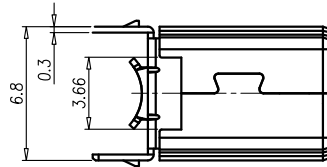

FRONT SHELL

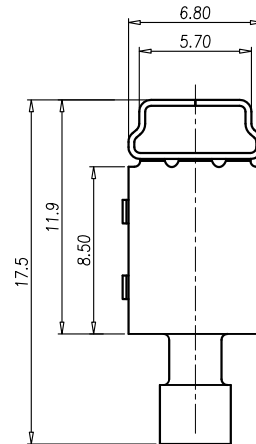

NOTE:

- 1.ELECTRICAL PROPERTIES:
 - 1-1.CONTACT CURRENT RATING:1A AT 250V AC MIN.
 - 1-2.CONTACT RESISTANCE:50m Ohm MAX
 - 1-3.INSULATION RESISTANCE:100M Ohm MIN.
 - 1-4.DIELECTRIC WITHSTANDING VOLTAGE:AC 100V/1 MINUTE.
- 2.MATERIAL:
 - 2-1.PIN:PHOSPHOR BRONZE
 - 2-2.HOUSING: LCP,UL 94V-0.
 - 2-3.BACK COVER:PBT + 30% GF,UL94V-0.
 - 2-4.COVER SHELL:BRASS.
 - 2-5.BASE SHELL:BRASS.
- 3.PLATING:
 - 3-1.CONTACT : CONTACT AREA : GOLD 5u" SOLDER AREA : BRIGHT TIN UNDERPLATED : NICKEL
 - 3-2.SHELL: NICKEL OVER ALL 60u" MIN.

RoHS Compliant

TOLERANCES ARE

MORETHANALL
PCB CONNECTORS
Cable ASSEMBLIES

煜倫股份有限公司

www.morethanall.com

DRAWING BY CY

CHECKED BY GENIUS

UNIT / mm

SCALE 1 : 1

DATE

SIZE A4

X, ±
.X ±
.XX ±
.XXX ±
ANG ±

PJECTION

照片框

ORDER INFORMATION

MSB-PSRV-5B-LF
SERIES | | LEADFREE
| | 5 PIN B TYPE
| | 90 ° REVERSED
SOLDER
MALE

DESCRIPTION: MiniUSB 5PIN(M) 90度反向成品(加長)