

Specifications:

Current rating:5.0A AC,DC
 Voltage rating:250V AC, DC
 Contact test resistance:10m ohm Max
 Insulation resistance:1000M ohm Min
 Withstanding voltage:AC 1500V AC/minute
 Operating Temperature:-25°C ~ +105°C
 Materials:

Insulator:High Temp Plastic (Nylon 46 UL94V-0)
 Insulator Color:Black
 Contact:Copper Alloy
 Finish:Tin Plated

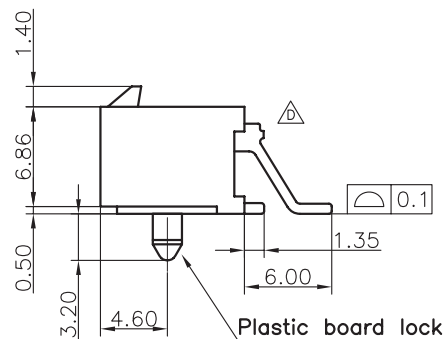
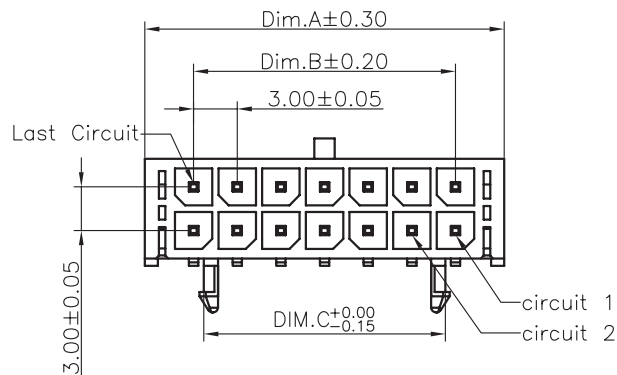

Circuits	Dimension			Circuits	Dimension		
	A	B	C		A	B	C
2	6.7	—	2.9	14	24.7	18.0	16.6
4	9.7	3.0	2.9	16	27.7	21.0	19.6
6	12.7	6.0	2.9	18	30.7	24.0	22.6
8	15.7	9.0	7.6	20	33.7	27.0	25.6
10	18.7	12.0	10.6	22	36.7	30.0	28.6
12	21.7	15.0	13.6	24	39.7	33.0	31.6

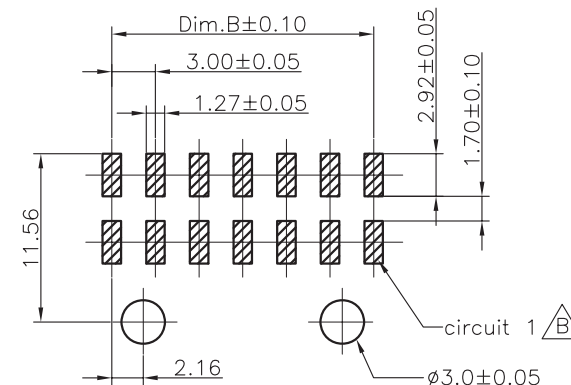
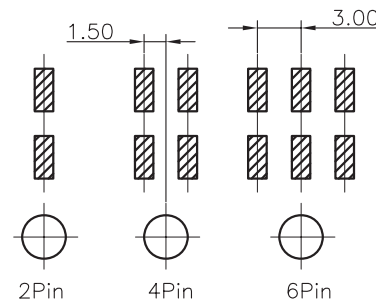

PCB Layout

RoHS Compliant

RoHS Compliant

TOLERANCES ARE

MORETHANALL
 PCB CONNECTORS
 Cable ASSEMBLIES

煜倫股份有限公司

www.morethanall.com

DRAWING BY CY

CHECKED BY GENIUS

UNIT/mm SCALE 1:1

DATE

SIZE A4

X.±
 .X±
 .XX±
 .XXX±
 ANG±

PJECTION

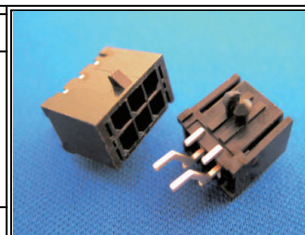

ORDER INFORMATION

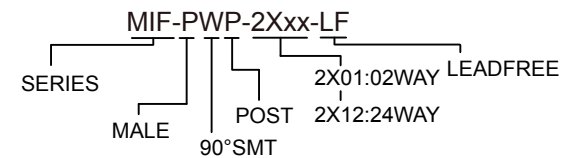

DESCRIPTION: 3.0mm Pitch Power Wafer SMD Type

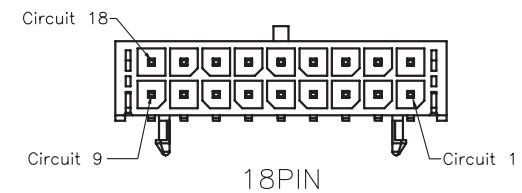
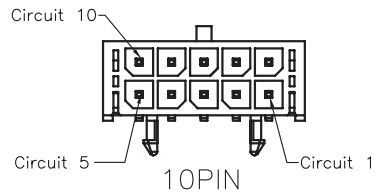
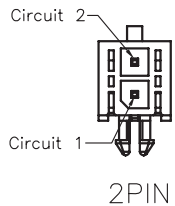
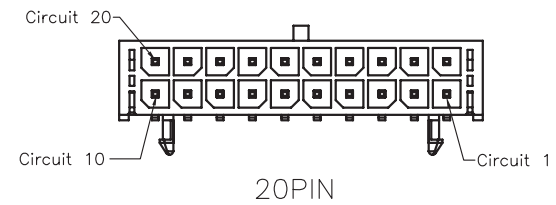
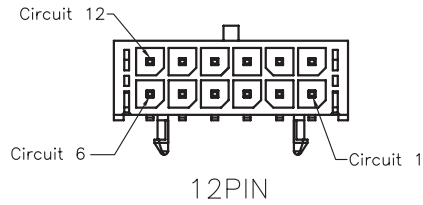
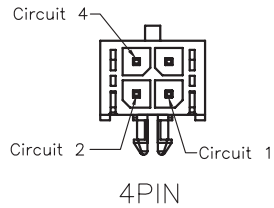
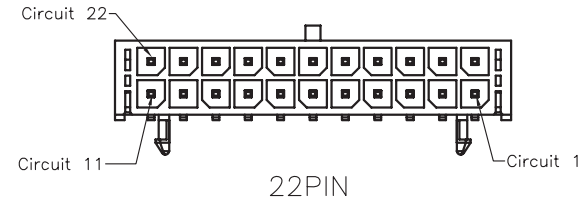
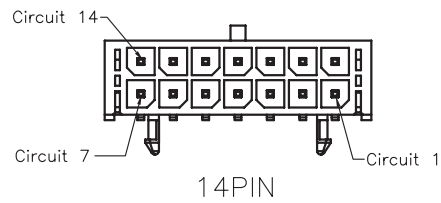
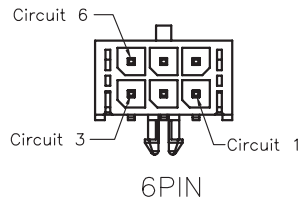
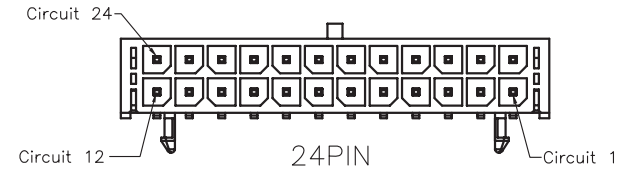
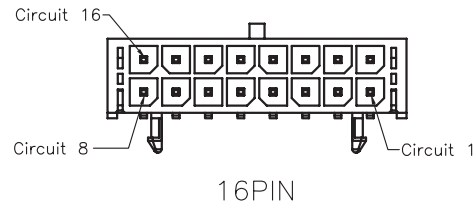
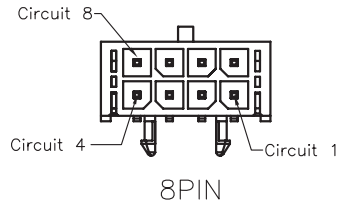

2~24P Protection Key Drawing(Ref.)

RoHS Compliant

TOLERANCES ARE

MORETHANALL
PCB CONNECTORS
Cable ASSEMBLIES

DRAWING BY CY

CHECKED BY GENIUS

UNIT/ mm

SCALE 1:1

DATE

SIZE A4

X, ±
.X ±
.XX ±
.XXX ±
ANG ±

P PROJECTION

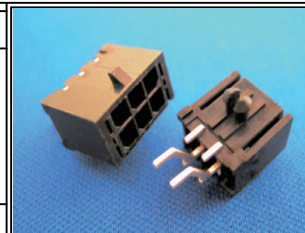

ORDER INFORMATION

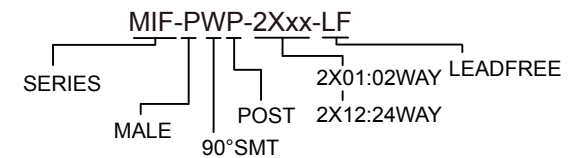

DESCRIPTION: 3.0mm Pitch Power Wafer SMD Type

煜倫股份有限公司

www.morethanall.com