

10P~24P:The first 4pin kink and last 4pin Kink

Circuits	Dimension		Circuits	Dimension	
	A	B		A	B
2	6.7	—	14	24.7	18.0
4	9.7	3.0	16	27.7	21.0
6	12.7	6.0	18	30.7	24.0
8	15.7	9.0	20	33.7	27.0
10	18.7	12.0	22	36.7	30.0
12	21.7	15.0	24	39.7	33.0

Specifications:  
 Current Rating:5.0A AC/DC  
 Voltage Rating:250V AC/DC  
 Contact Resistance:10m ohm. Max.  
 Insulation Resistance:1000M ohm. Min.  
 Withstanding Voltage:AC 1500V AC/minute  
 Operating Temperature Range:-25°C ~ +105°C

Material and Finish  
 Insulator:High Temp. Plastic (LCP UL94V-0)  
 Insulator Color:Black  
 Terminal:Copper Alloy  
 Finish:Tin Plated

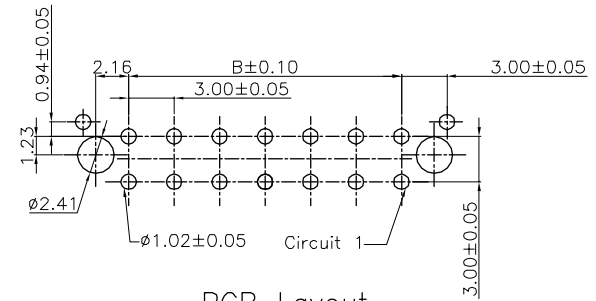

PCB Layout

RoHS Compliant

TOLERANCES ARE

**MORETHANALL**  
 PCB CONNECTORS  
 Cable ASSEMBLIES

DRAWING BY CY

X. ±

CHECKED BY GENIUS

.X ± 0.20

UNIT / mm

SCALE 1 : 1

.XX ± 0.15

DATE

.XXX ±

ANG ±

SIZE A4

PJECTION

照片框

ORDER INFORMATION

MIF-PDPZ-2Xxx-LF  
 SERIES LEADFREE  
 MALE CLIP POST  
 DIP 180°  
 2X01:02WAY  
 2X12:24WAY

DESCRIPTION: 3.0mm Pitch Power Wafer Straight Type

煜倫股份有限公司

www.morethanall.com

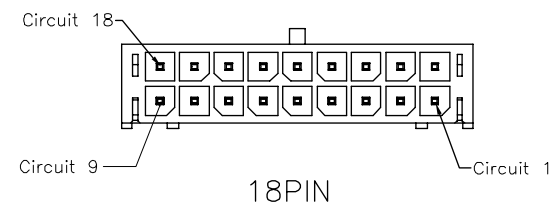
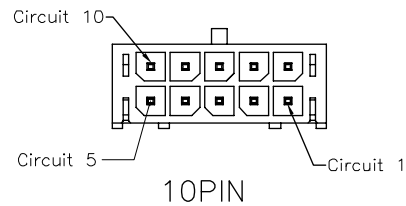
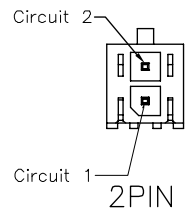
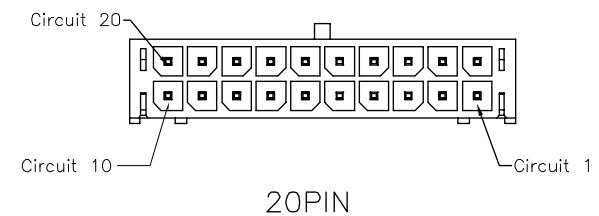
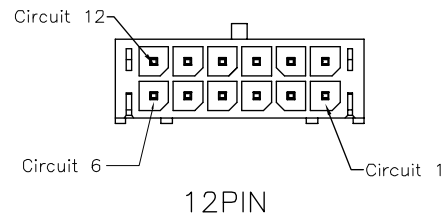
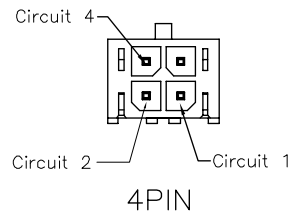
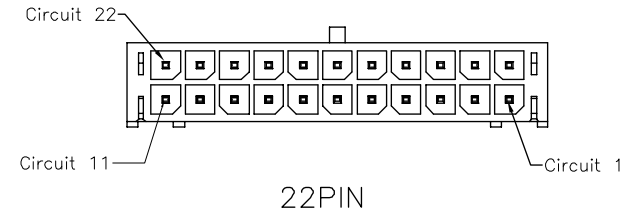
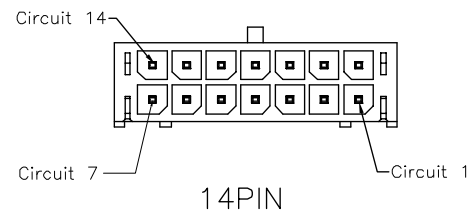
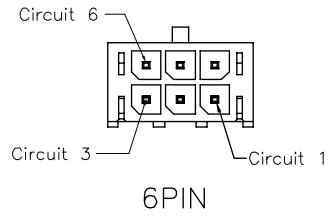
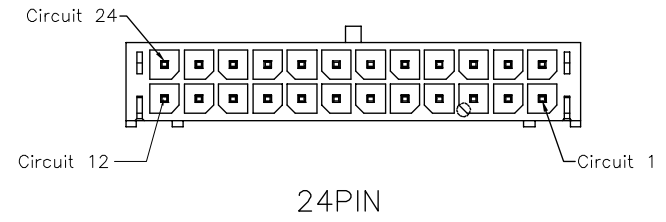
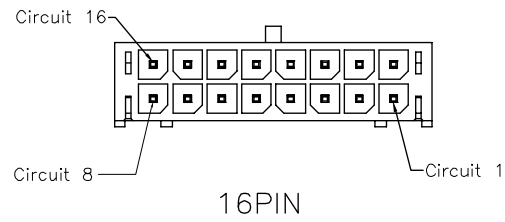
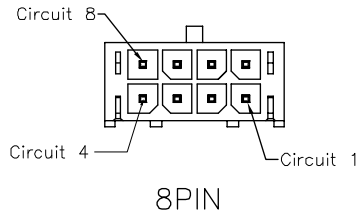

2~24P Protection Key Drawing(Ref.)

RoHS Compliant

TOLERANCES ARE

**MORETHANALL**  
PCB CONNECTORS  
Cable ASSEMBLIES

DRAWING BY CY

CHECKED BY GENIUS

UNIT / mm

SCALE 1 : 1

DATE

SIZE A4

X, ±  
.X ± 0.20  
.XX ± 0.15  
.XXX ±  
ANG ±

PJECTION

照片框

ORDER INFORMATION

MIF-PDPZ-2Xxx-LF  
SERIES | LEADFREE  
2X01:02WAY  
2X12:24WAY  
MALE | CLIP  
POST  
DIP 180°

DESCRIPTION: 3.0mm Pitch Power Wafer Straight Type

煜倫股份有限公司

www.morethanall.com