

Unit:mm			
Part NO.	Dim A	P.C.B Thickness	
MDSP-SRW55PMR-20	2.15~2.30	1.20	

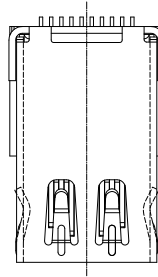

Top Row			Bottom Row		
Pin NO.	Signal Type	Pin Name	Pin NO.	Signal Type	Pin Name
1	GND	GND	2	In	HotPlug Detect
3	Out	ML_Lane 0(p)	4	CONFIG	CONFIG1
5	Out	ML_Lane 0(n)	6	CONFIG	CONFIG2
7	GND	GND	8	GND	GND
9	Out	ML_Lane 1(p)	10	Out	ML_Lane 3(p)
11	Out	ML_Lane 1(n)	12	Out	ML_Lane 3(n)
13	GND	GND	14	GND	GND
15	Out	ML_Lane 2(p)	16	I/O	AUX_CH(p)
17	Out	ML_Lane 2(n)	18	I/O	AUX_CH(n)
19	GND	GND	20	PWR Out	DP_PWR

NOTES:

***Material**

Body: LCP+50%G.F UL94V-0 Color:Black
 Insert(Molding): LCP+30%G.F UL94V-0 Color:Black
 Retainer: LCP+50%G.F UL94V-0 Color:Black
 Contact: Phosphor Bronze;
 Plating: Gold plating over Nickel(40~80U")
 on contact area,Tin(100~250U")
 Plating on Solder Tail.
 Shell: Brass;
 Plating: Nickle(40~80U") Plating.

***Mechanical**

Insertion Force: 4.5Kg Max
 Withdrawal Force: 1.0~4.0Kg Min
 Durability: 10000 Cycles

***Electrical Specification**

Current Rating: 0.5 Ampere per contact
 Contact Resistance: 30 mΩ max.
 Insulation Resistance: 100MΩ Min
 Dielectric Withstanding Voltage: 500V AC Min

***Environmental**

Operating Temperature: -40°C to +85°C.

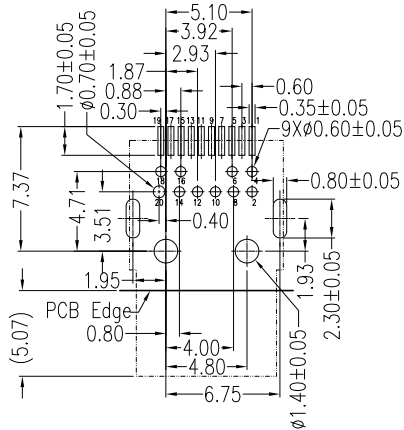
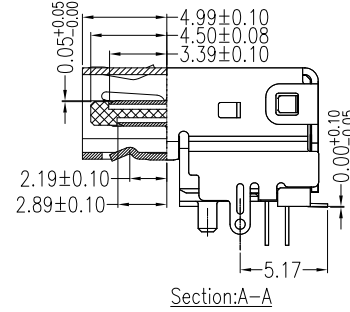
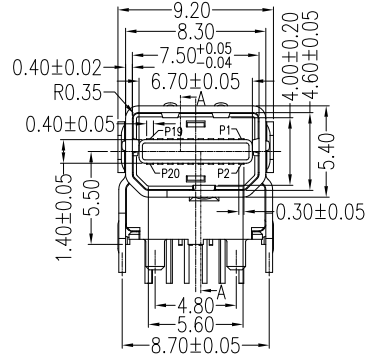
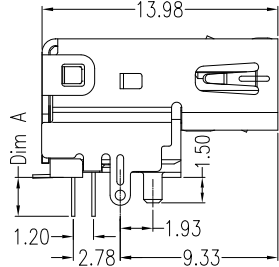

P.C.B Layout
Component side

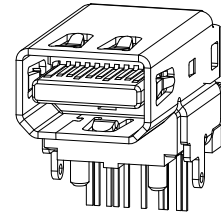
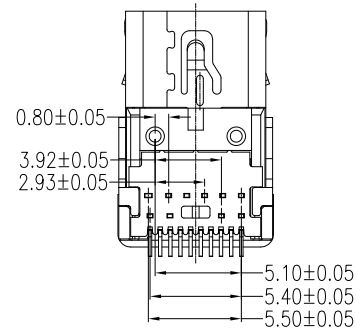

RoHS Compliant

TOLERANCES ARE



DRAWING BY CY

CHECKED BY GENIUS

UNIT / mm

SCALE 1 : 1

DATE

SIZE A4

- X, ±
- .X ±
- .XX ±
- .XXX ±
- ANG ±

PPOJECTION



ORDER INFORMATION

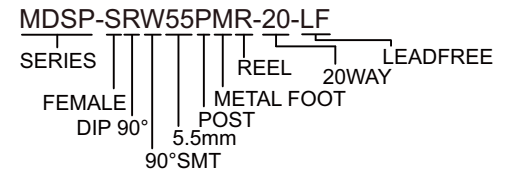

DESCRIPTION: Mini Displayport Receptacle DIP+SMT (APPLE 5.5) No Mark

煜倫股份有限公司

www.morethanall.com

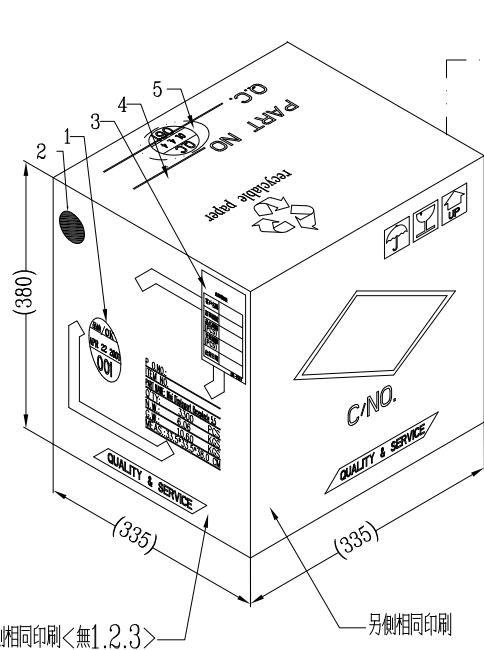

另側相同印刷<無1.2.3>

另側相同印刷

***加蓋印記位置**

1. 品管注介章(檢驗合格章)
2. 月份標記
3. 出貨明細表
4. 該產品料號.
5. 生產制造日期, 檢驗員代號.
6. 紙箱尺寸為內空間尺寸.

類型	材質	規格(Unit:mm)	數量
外箱	A=A	335*335*380	1PCS
隔板	A A	332*332*3	2PCS
旋轉膠盤	PC	φ330*φ100	10PCS
承載膠帶	PS(黑)	32(W)*5952(L)*0.50(T)	10PCS
封裝膠帶	PET	25.5(W)*5952(L)*0.05(T)	0.20PCS
PE袋	PE	600(開口)*1000*0.05	1PCS

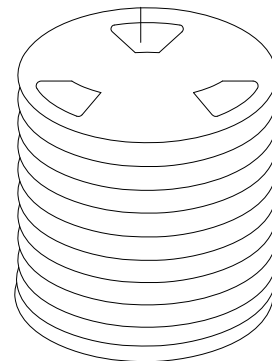

10 REELS

隔板: 2PCS(上下各1PCS)

- 注: 1. 成品組裝完成並QC完之後, 將其裝入承載帶內, 同時用封裝膠帶熱封。
 2. 檢查REEL包裝卷帶是否有鬆動, 如有鬆動, 需重新貼緊。
 3. 全檢OK後, 將Reel裝入PE袋, 底內放一包干燥劑, FQC復檢。
 4. 每一REEL卷盤上都要貼上料號和數量, 若有特殊要求請貼上客戶料號等, 標籤貼在圓孔的一邊。
 5. 產品裝好REEL后, 拉出端空16PCS, 卷入端空26PCS不放產品。

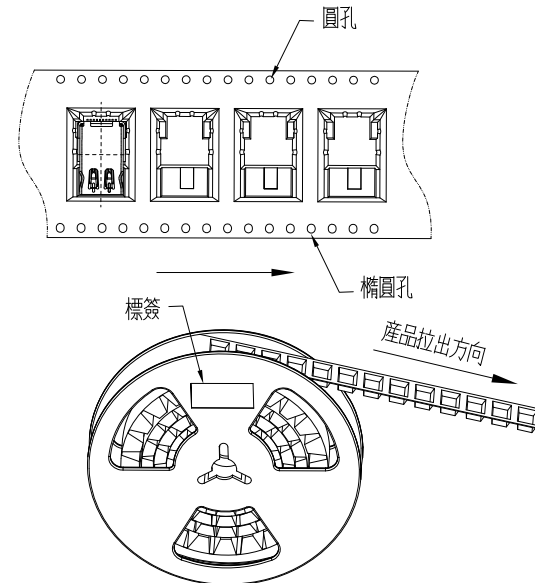

出貨明細表	
客戶名稱	
訂單編號	
品名規格	
交貨總數 (PCS)	
單箱數量 (PCS)	
出貨日期	

QR-1504

***PACKING**

330 PCS/REEL
 10 REELS/CARTON(共計3300pcs)

***PACKING DETAILS**

P/O.NO.:
 ITEM NO.: MDSP-SRW55PMR-20
 PART NAME: Mini Displayport Receptacle 5.5
 Q'TY: 3300 PCS
 N.W.: 6.06 KGS
 G.W.: 10.60 KGS
 MEAS.: 33.5*33.5*38.0 CM

RoHS Compliant

TOLERANCES ARE

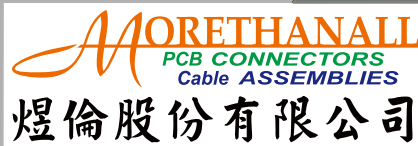

www.morethanall.com

DRAWING BY CY
 CHECKED BY GENIUS
 UNIT / mm SCALE 1 : 1
 DATE
 SIZE A4 PPROJECTION

X, ±
 .X ±
 .XX ±
 .XXX ±
 ANG ±



ORDER INFORMATION

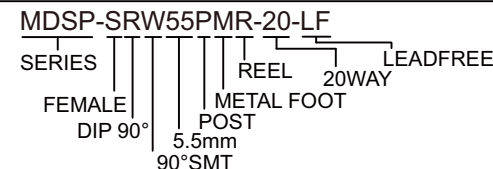

DESCRIPTION: Mini Displayport Receptacle 5.5 Reel 包裝規範圖