

03P

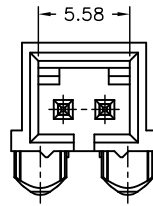

02P

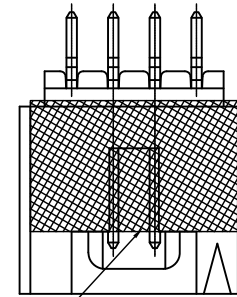
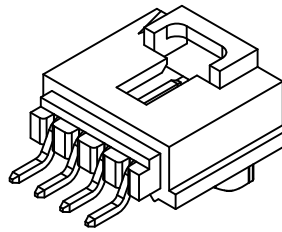

KAPTON TAPE
(FOR PICK AND
PLACE SYSTEMS)

SPECIFICATIONS

Current Rating: 3A AC,DC
Voltage Rating: 250V AC,DC
Temperature Range: -25°C ~ +85°C
Contact Resistance: 20mΩ Max.
Insulation Resistance: 1000MΩ Min.
Withstanding Voltage: 1500V AC/minute
Pin Material: Brass/Gold-flash
Material: Nylon 6T,UL94V-0
Color: Natural(Black)

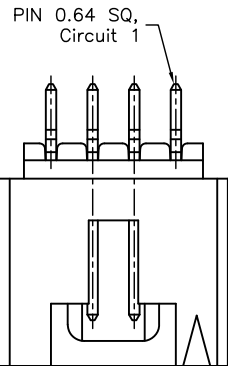

(TOP VIEW)

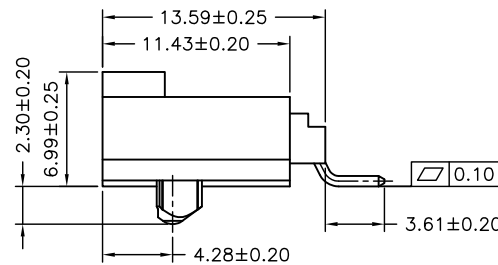
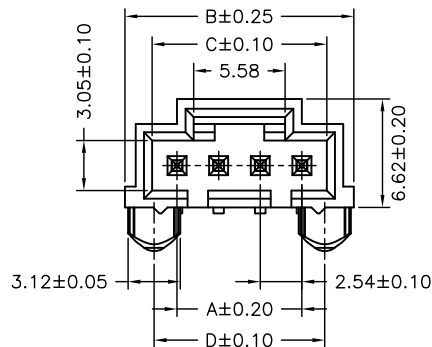
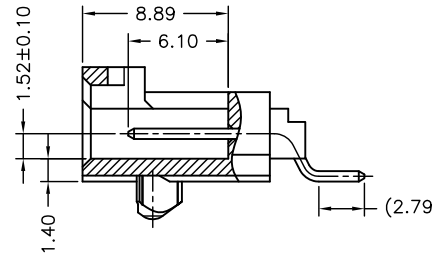
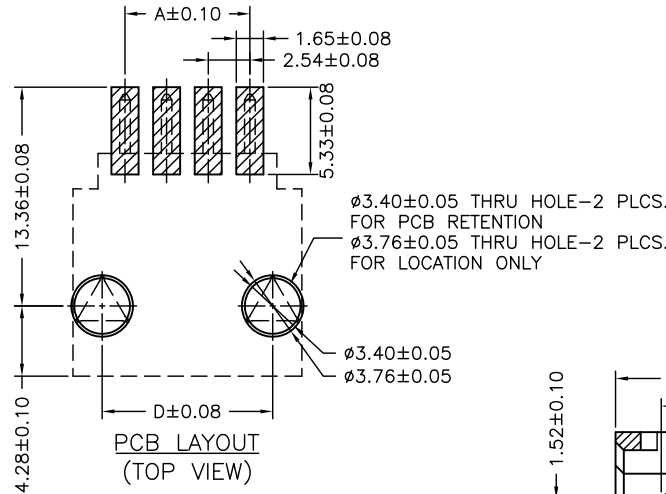

Circuit No.	Dimensions			
	A	B	C	D
02P	2.54	8.89	---	5.33
03P	5.08	11.43	8.12	7.87
04P	7.62	13.97	10.66	10.41
05P	10.16	16.51	13.20	12.95
06P	12.70	19.05	15.74	15.49
07P	15.24	21.59	18.28	18.03
08P	17.78	24.13	20.82	20.57
09P	20.32	26.67	23.36	23.11
10P	22.86	29.21	25.90	25.65
11P	25.40	31.75	28.44	28.19
12P	27.94	34.29	30.98	30.73

RoHS Compliant

TOLERANCES ARE

MORETHANALL
PCB CONNECTORS
Cable ASSEMBLIES

DRAWING BY CY

CHECKED BY GENIUS

UNIT / mm

SCALE 1 : 1

DATE

SIZE A4

X, ±
.X ± 0.25
.XX ± 0.15
.XXX ± 0.05
ANG ±

P PROJECTION

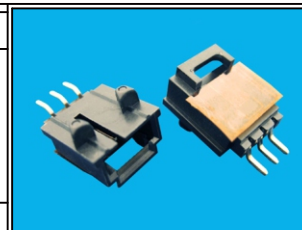

ORDER INFORMATION

MCG-WPC-1Xxx-LF

SERIES

LEADFREE
1X02:02WAY
1X12:12WAY
MYLAR
POST
90° SMT

DESCRIPTION: 2.54mm PITCH 90° WAFER-SMT TYPE

煜倫股份有限公司

www.morethanall.com