

• **MATERIALS:(RoHS Compliant)**

Housing And Cover : Plastic Thermoplastic
 P.B.T UL94V-0 Black
 Contacts : Phosphor Bronze Gold
 Selective Plated
 Bracket : Zinc Alloy Nickel
 Plated Over Copper

• **ELECTRICAL CHARACTERISTICS:**

Contact Current Rating: 1 Amp
 Dielectric Withstanding Voltage: 500V AC
 Insulation Resistance: >500MΩ/Min
 Contact Resistance: 35mΩ/Max
 Operation Temperature: -55°C ~ +105°C

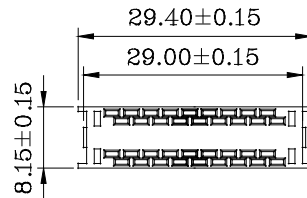
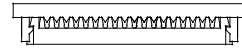
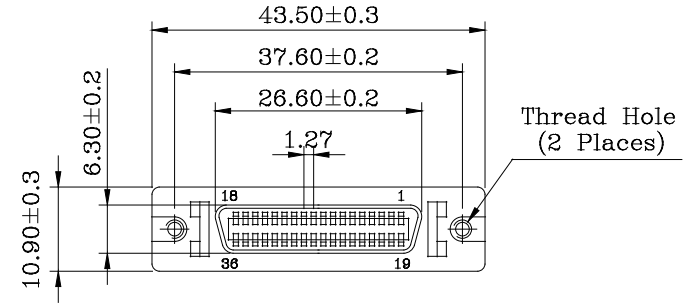
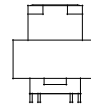
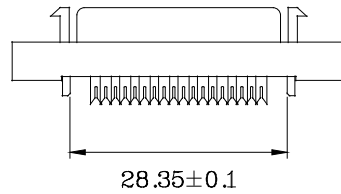

Termination Cover
(1 Places)

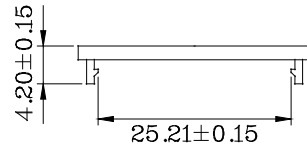
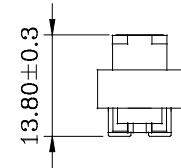
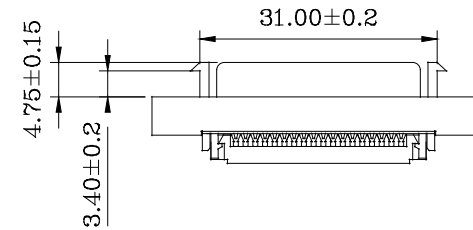

Wire Holder
(2 Places)

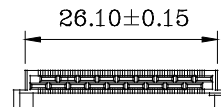
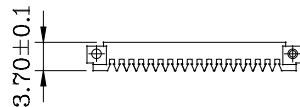

RoHS Compliant

TOLERANCES ARE

MORETHANALL
 PCB CONNECTORS
 Cable ASSEMBLIES

煜倫股份有限公司

www.morethanall.com

DRAWING BY CY

CHECKED BY GENIUS

UNIT / mm

SCALE 1 : 1

DATE

SIZE A4

PJECTION

X. ±
 .X ±
 .XX ±
 .XXX ±
 ANG ±

照片框

ORDER INFORMATION

HPC-SFL-036-LF
 SERIES | LEADFREE
 | 36 WAY
 | LOCK
 | IDC
 | FEMALE

DESCRIPTION: 1.27mm (.050") Ribbon 36Pos Cable Receptacles Connector I.D.C Type