

● **MATERIALS: (RoHS Compliant)**

Hood: Plastic Thermoplastic ABS UL 94V-0
 Latch Cover: Plastic Thermoplastic ABS UL 94V-0
 Latch: Stainless Steel
 Inner Shell: Steel Nickel Plated Over Copper

Housing And Cover: Plastic Thermoplastic
 P.B.T UL94V-0 Black
 Contacts: Phosphor Bronze Gold
 Selective Plated
 Front Shell: Steel Nickel Plated
 Over Copper

● **ELECTRICAL CHARACTERISTICS:**

Contact Current Rating: 0.5 Amp
 Dielectric Withstanding Voltage: 500V AC
 Insulation Resistance: >500MΩ/Min
 Contact Resistance: 35mΩ/Max
 Operation Temperature: -55°C ~ +85°C

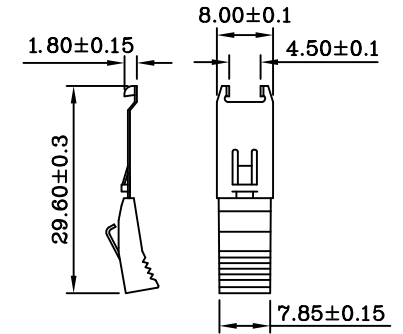

Flag Hooks

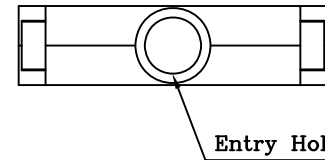

Entry Hole

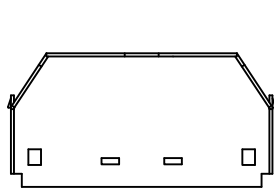
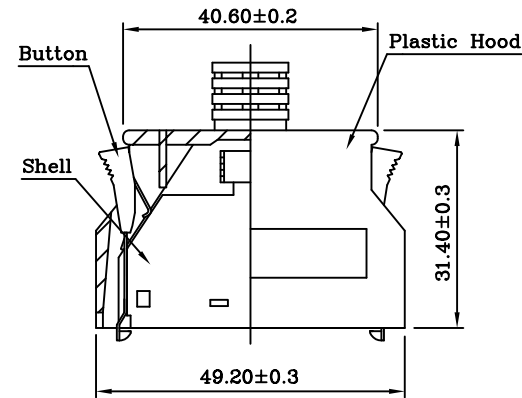

Upper Cover

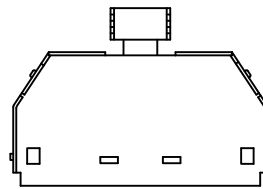

Lower Cover

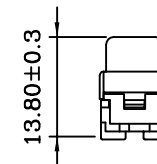
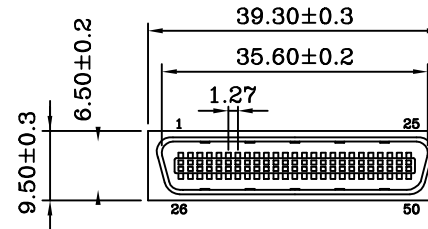
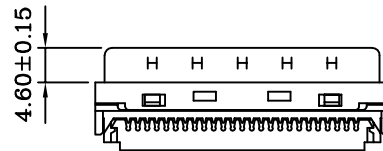
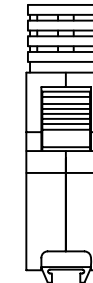

RoHS Compliant

TOLERANCES ARE

MORETHANALL
 PCB CONNECTORS
 Cable ASSEMBLIES

煜倫股份有限公司

www.morethanall.com

DRAWING BY CY
 CHECKED BY GENIUS
 UNIT/mm SCALE 1:1
 DATE
 SIZE A4 PROJECTION

X.±
 .X±
 .XX±
 .XXX±
 ANG±

照片框

ORDER INFORMATION

HPC-PFQ-050-LF
 SERIES | LEADFREE
 | 50 WAY
 | Q TYPE COVER
 | IDC
 | MALE

DESCRIPTION: 1.27mm(.050") Series 50Pos Plastic Hood With Spring Latches