

SERIES D-SUB MINIATURE ACCESSORIES  
 09P, LONG SCREW  
 HOOD MATERIAL: CRS/POLYESTER  
 FINISH: A> HOOD - CHROME PLATED  
 B> SCREW NUT & CLIP AND OTHER, NICKEL PLATED

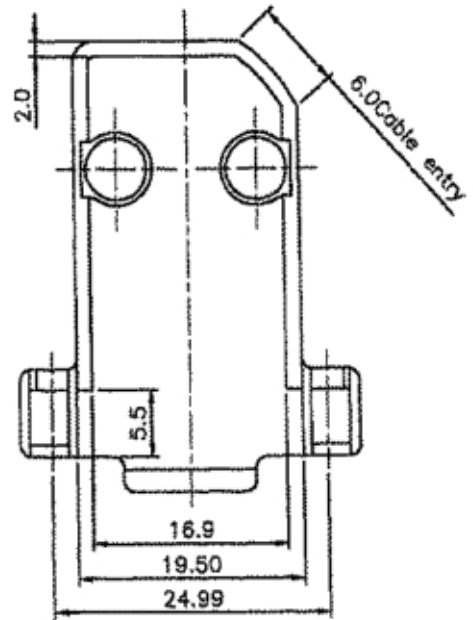
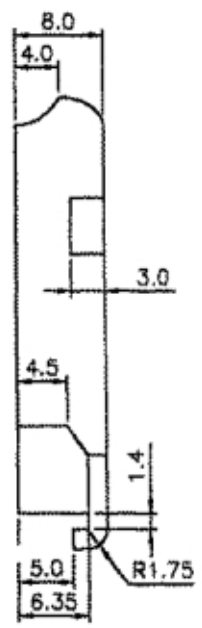
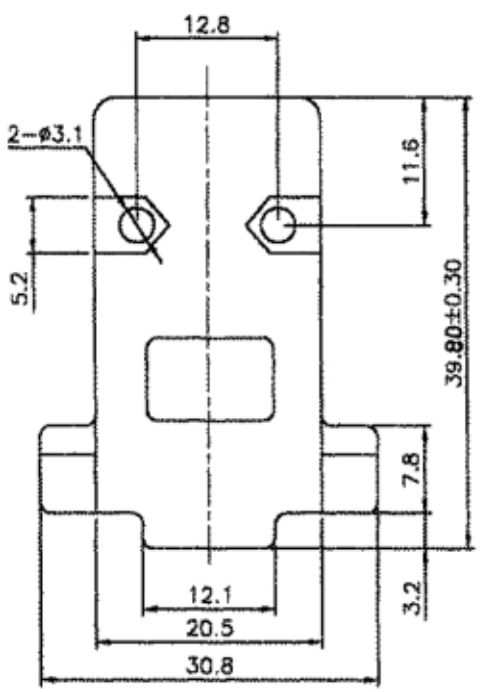

G: Gray  
 B: Black  
 C: Chromate Cloir  
 No. Of Postions

DHS-x1T-09-LF  
 LEADFREE  
 G:GRAY T:THUMBSCREWS  
 K:BLACK C:CHROMATE

RoHS Compliant

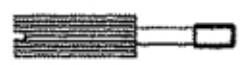

2PCS

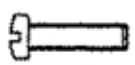

2PCS

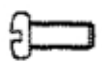

2PCS



2PCS

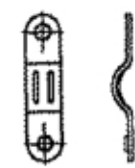

2PCS



PART NO. DHS-x1T-09

DWG NO. DHS-x1T-09

CHECKED BY CY

TOLERANCES ARE

DESCRIP TION:

FILE NO.

DRAWING BY

.X ± 0.2  
 .XX ± 0.1  
 .XXX ±  
 AWG

煜倫股份有限公司

UNIT / mm

SCALE 1:1

PROJECTION

AREA

REVISIONS

HK

DATE