

MATERIAL
 INSULATOR:ABS UL94HB
 SCREW:STEEL
 FINISHED:CHROMATE PLATED

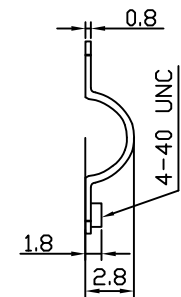
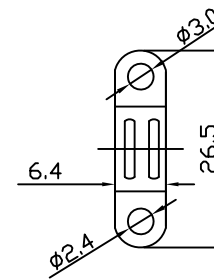
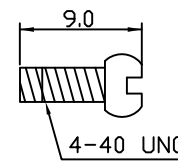
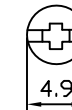
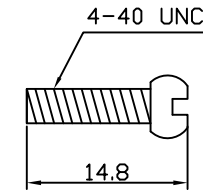
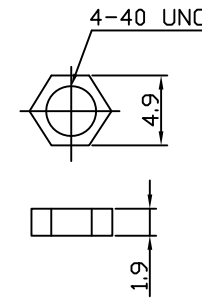
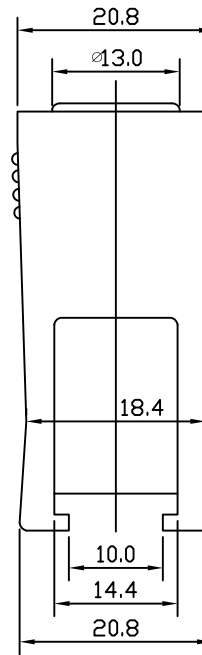
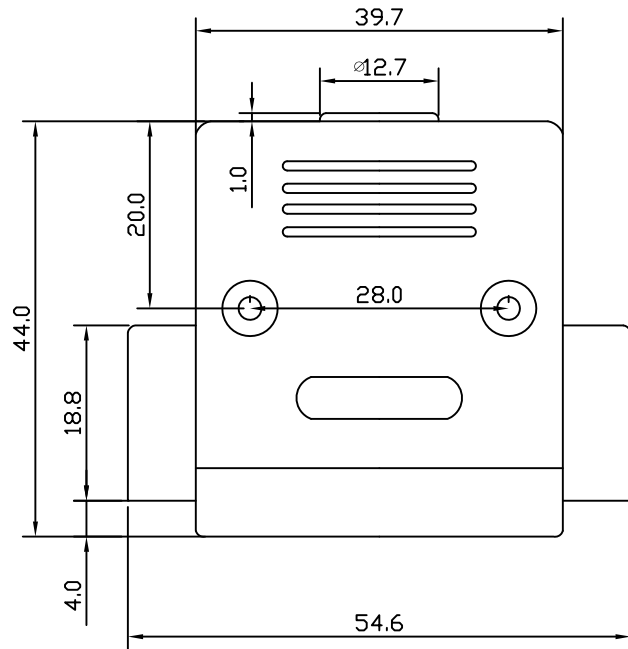

RoHS Compliant

TOLERANCES ARE

MORETHANALL
 PCB CONNECTORS
 Cable ASSEMBLIES

煜倫股份有限公司

www.morethanall.com

DRAWING BY CY

CHECKED BY GENIUS

UNIT / mm SCALE 1 : 1

DATE

SIZE A4

X. ± 0.50
 .X ± 0.30
 .XX ± 0.20
 .XXX ±
 ANG ±

P PROJECTION

照片框

ORDER INFORMATION

DHL-x1T-25-LF

SERIES

LEADFREE
 25WAY
 THUMBSCREW
 SINGLE PACKING

B:BEIGE
 C:CHROMATE PLATED
 G:GRAY
 K:BLACK

DESCRIPTION: