

- Material: * Insulator: Nylon 6T UL 94V-0 (Milky Yellow)
 * Contact Post: 0.35mm^t Phosphor Bronze, Matte Tin Plated.
 * Solder Tab: 0.20mm^t Brass, Matte Tin Plated.

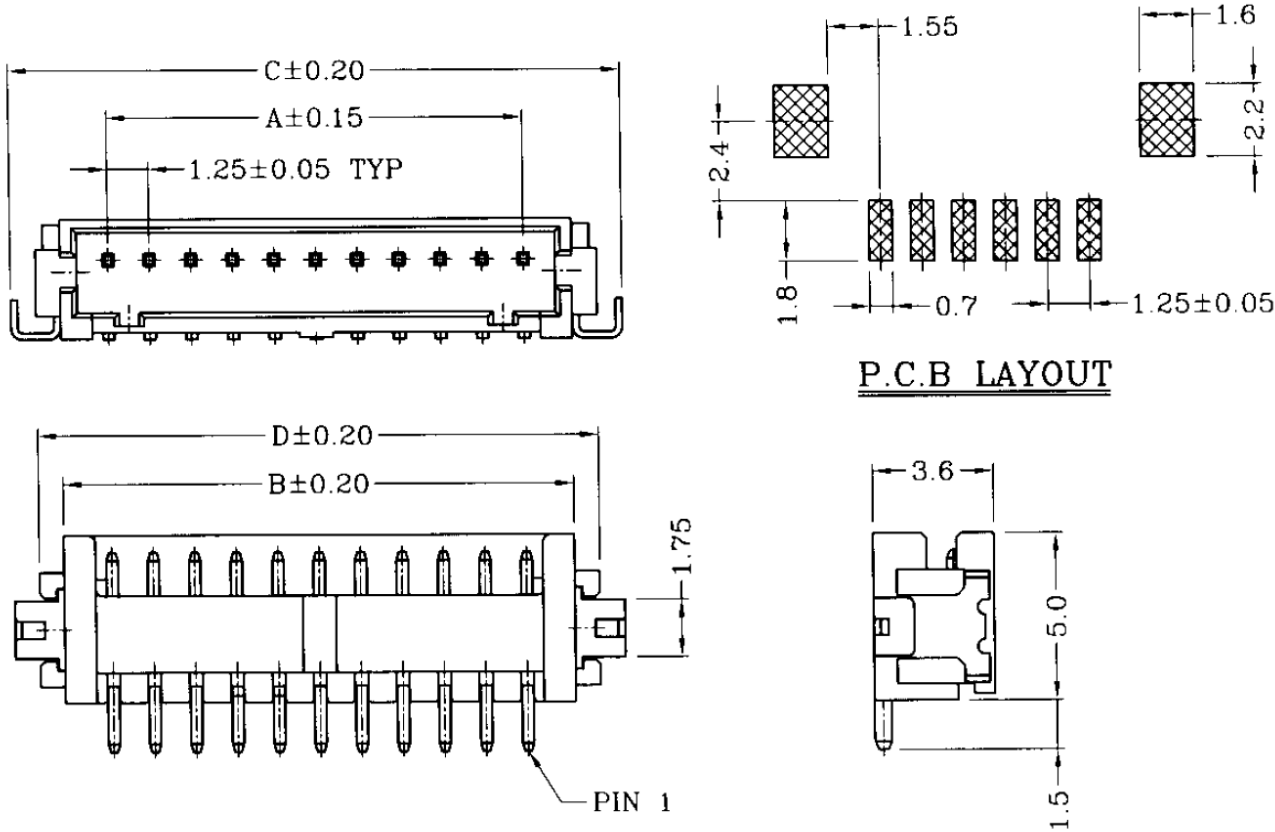

P.C.B LAYOUT

Dimensional & Ordering Information:

Circuits	Dimensions				Qty/Reel
	A	B	C	D	
2	—	4.15	7.15	5.65	1000 Pcs
3	2.50	5.40	8.40	6.90	1000 Pcs
4	3.75	6.65	9.65	8.15	1000 Pcs
5	5.00	7.90	10.90	9.40	1000 Pcs
6	6.25	9.15	12.15	10.65	1000 Pcs
7	7.50	10.40	13.40	11.90	1000 Pcs
8	8.75	11.65	14.65	13.15	1000 Pcs
9	10.00	12.90	15.90	14.40	1000 Pcs
10	11.25	14.15	17.15	15.65	1000 Pcs
11	12.50	15.40	18.40	16.90	1000 Pcs
12	13.75	16.65	19.65	18.15	1000 Pcs
13	15.00	17.90	20.90	19.40	1000 Pcs
14	16.25	19.15	22.15	20.65	1000 Pcs
15	17.50	20.40	23.40	21.90	1000 Pcs

RoHS Compliant

TOLERANCES ARE

MORETHANALL
 PCB CONNECTORS
 Cable ASSEMBLIES

DRAWING BY CY

CHECKED BY GENIUS

UNIT / mm

SCALE 1 : 1

DATE

SIZE A4

PJECTION

X, ±
 .X ± 0.25
 .XX ± 0.15
 .XXX ± 0.08
 ANG ±

照片框

ORDER INFORMATION

DF13-WXR-1Xxx-LF

SERIES

LEADFREE

1X02:02WAY

1X15:15WAY

REEL

NON POST

90°SMT

煜倫股份有限公司

www.morethanall.com

DESCRIPTION:

Feeding Direction →

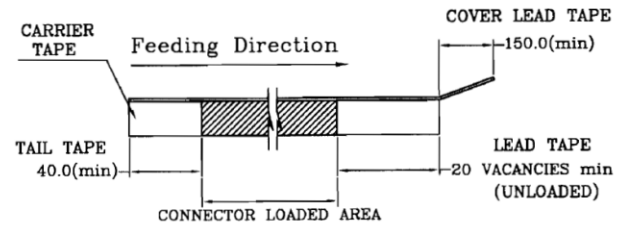
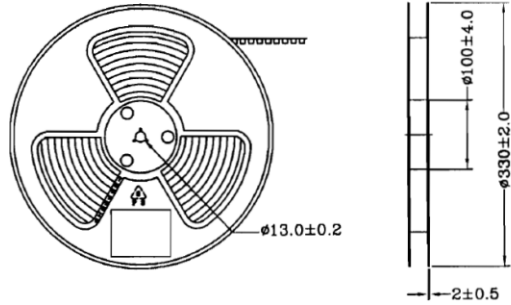

2 to 4 circuits
Feeding Direction →

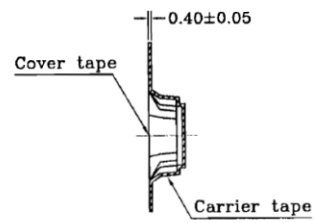
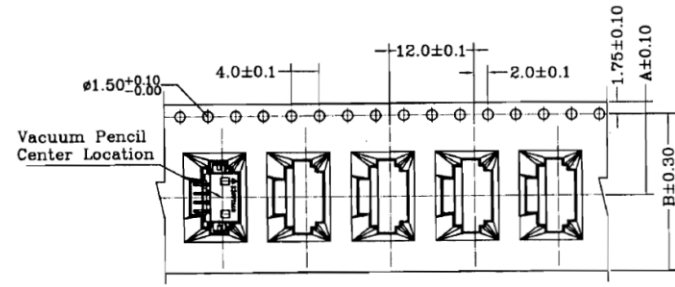

5 to 15 circuits
Feeding Direction →

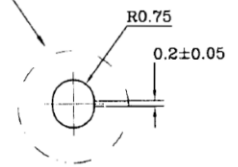
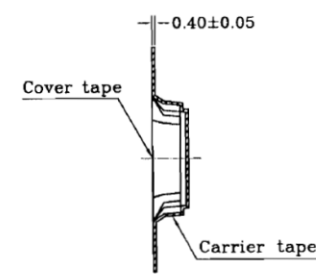
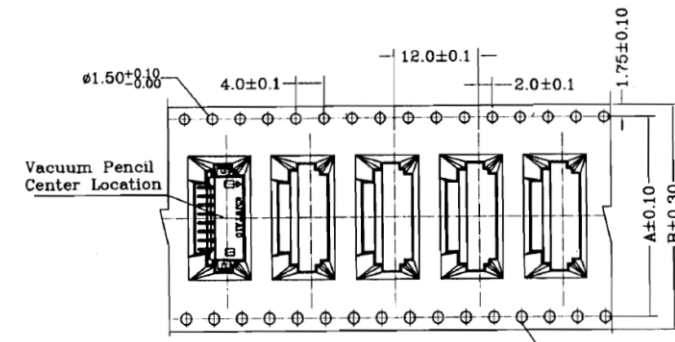

Circuits	Dimensions		Qty/Reel
	A	B	
2	11.50	24.00	1000
3	11.50	24.00	1000
4	11.50	24.00	1000
5	28.40	32.00	1000
6	28.40	32.00	1000
7	28.40	32.00	1000
8	28.40	32.00	1000
9	28.40	32.00	1000
10	28.40	32.00	1000
11	40.40	44.00	1000
12	40.40	44.00	1000
13	40.40	44.00	1000
14	40.40	44.00	1000
15	40.40	44.00	1000

RoHS Compliant

TOLERANCES ARE

MORETHANALL
PCB CONNECTORS
Cable ASSEMBLIES

DRAWING BY CY

CHECKED BY GENIUS

UNIT / mm SCALE 1 : 1

DATE

SIZE A4

X, ±
.X ± 0.25
.XX ± 0.15
.XXX ± 0.08
ANG ±

PJECTION

煜倫股份有限公司

www.morethanall.com

照片框

ORDER INFORMATION

DF13-WXR-1Xxx-LF

SERIES | LEADFREE
1X02:02WAY
1X15:15WAY
REEL
NON POST
90°SMT

DESCRIPTION: