

- Material: * Insulator: Nylon 6T UL 94V-0 (Milky Yellow)
 * Contact Post: Phosphor Bronze, Matte Tin Plated
 * Solder Tab: 0.20mm^t Brass, Matte Tin Plated

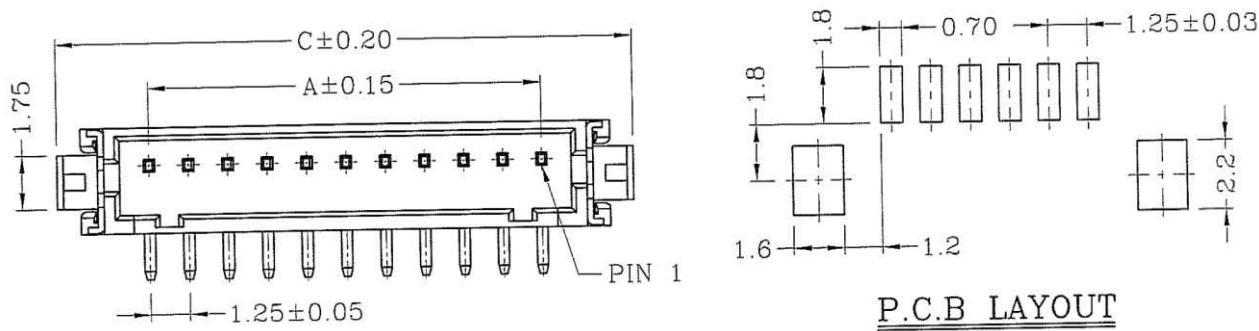

Dimensional & Ordering Information:

Circuits	Dimensions				Pcs/Reel
	A	B	C	D	
2	1.25	4.15	7.15	5.65	1000
3	2.50	5.40	8.40	6.90	1000
4	3.75	6.65	9.65	8.15	1000
5	5.00	7.90	10.90	9.40	1000
6	6.25	9.15	12.15	10.65	1000
7	7.50	10.40	13.40	11.90	1000
8	8.75	11.65	14.65	13.15	1000
9	10.00	12.90	15.90	14.40	1000
10	11.25	14.15	17.15	15.65	1000
11	12.50	15.40	18.40	16.90	1000
12	13.75	16.65	19.65	18.15	1000
13	15.00	17.90	20.90	19.40	1000
14	16.25	19.15	22.15	20.65	1000
15	17.50	20.40	23.40	21.90	1000

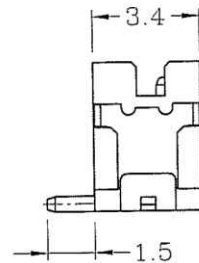
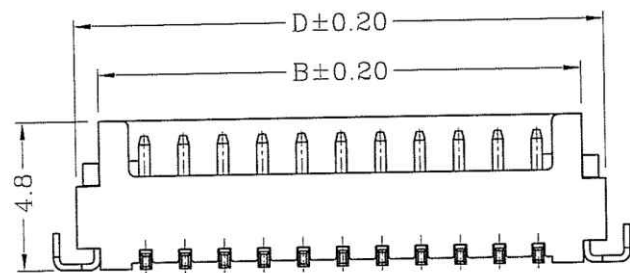

RoHS Compliant

TOLERANCES ARE

MORETHANALL
 PCB CONNECTORS
 Cable ASSEMBLIES

DRAWING BY CY

CHECKED BY GENIUS

UNIT / mm SCALE 1 : 1

DATE

SIZE A4

X, ±
 .X ±
 .XX ±
 .XXX ±
 ANG ±

P PROJECTION

照片框

ORDER INFORMATION

DF13-VXCR-1Xxx-LF
 SERIES | | | LEADFREE
 | | | 1X02:02WAY
 | | | 1X15:15WAY
 180°SMT REEL
 CAP
 NON POST

煜倫股份有限公司

www.morethanall.com

DESCRIPTION:

2 to 9 circuits

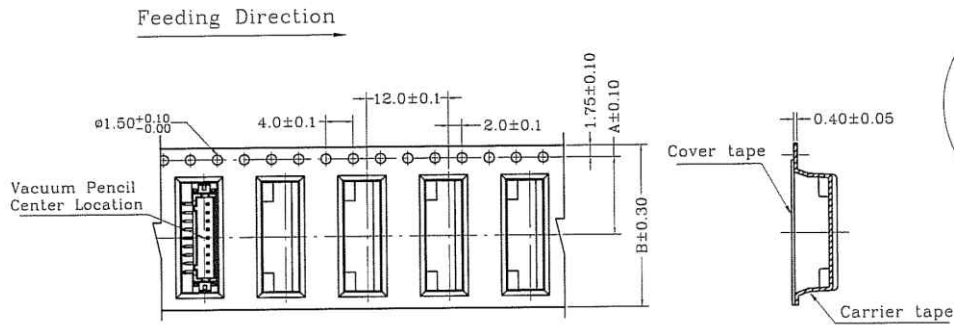

Feeding Direction

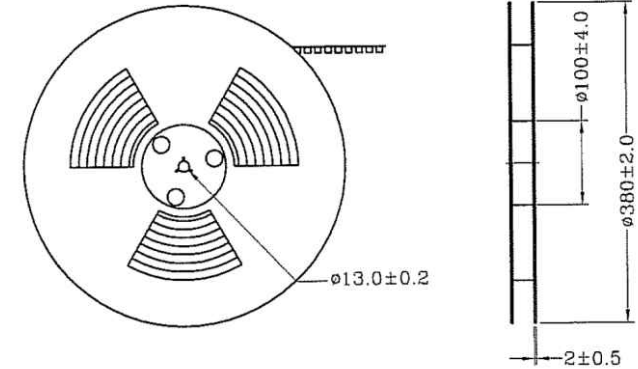

10 to 15 circuits

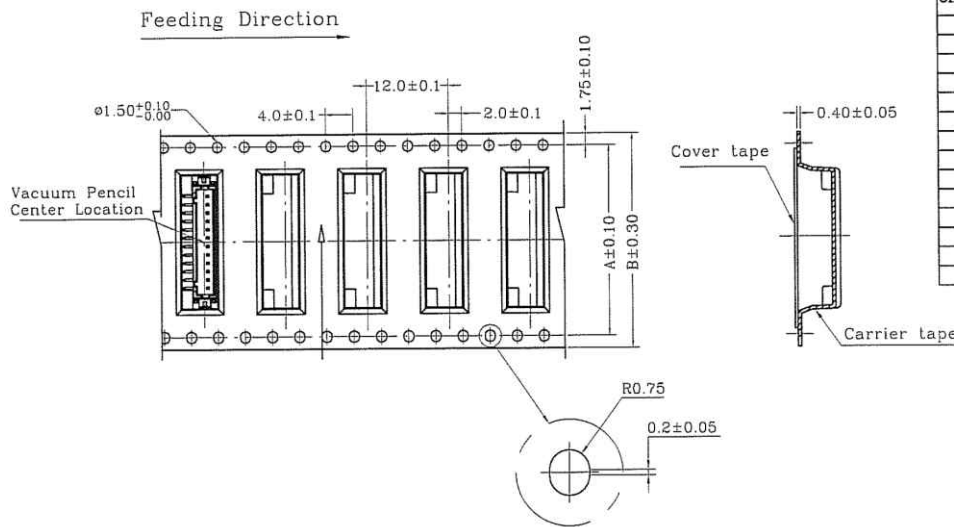

Circuits	Dimensions		Pcs/Reel
	A	B	
2	7.50	16.00	1000
3	7.50	16.00	1000
4	11.50	24.00	1000
5	11.50	24.00	1000
6	11.50	24.00	1000
7	11.50	24.00	1000
8	11.50	24.00	1000
9	11.50	24.00	1000
10	28.40	32.00	1000
11	28.40	32.00	1000
12	28.40	32.00	1000
13	40.40	44.00	1000
14	40.40	44.00	1000
15	40.40	44.00	1000

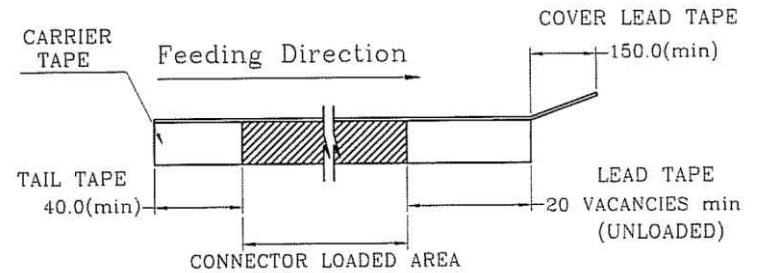

RoHS Compliant

TOLERANCES ARE

MORETHANALL
PCB CONNECTORS
Cable ASSEMBLIES

DRAWING BY CY

X, ±

CHECKED BY GENIUS

.X ±

UNIT / mm

SCALE 1 : 1

.XXX ±

DATE

ANG ±

煜倫股份有限公司

www.morethanall.com

SIZE A4

PJECTION

照片框

ORDER INFORMATION

DF13-VXCR-1Xxx-LF
SERIES | | | LEADFREE
| | | 1X02:02WAY
| | | 1X15:15WAY
180°SMT REEL
CAP
NON POST

DESCRIPTION: