

P.C.B LAYOUT

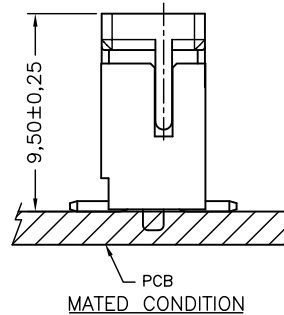

PCB MATED CONDITION

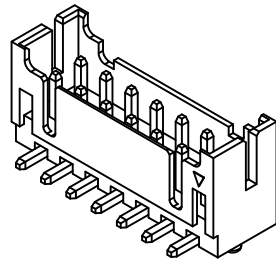
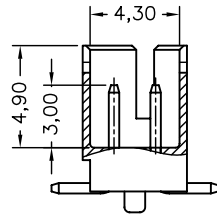
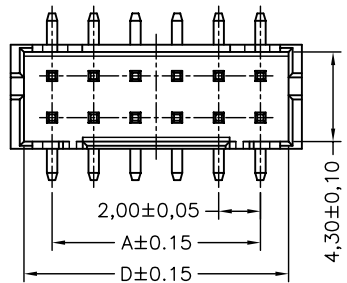

CAP (FOR PICK AND PLACE SYSTEMS)

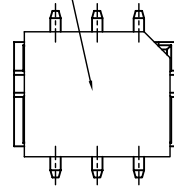

CAP (FOR PICK AND PLACE SYSTEMS)

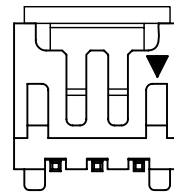
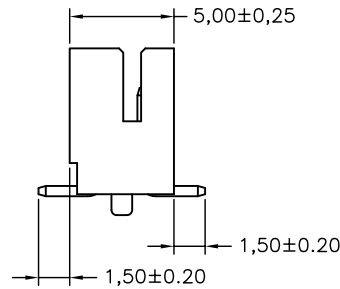
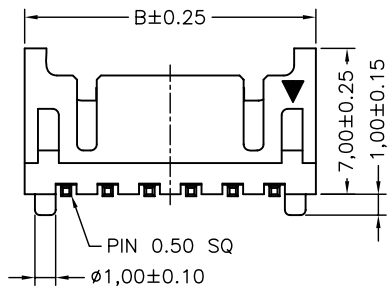
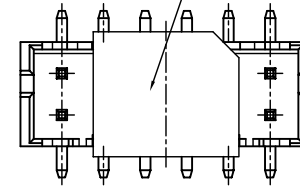

02P~03P

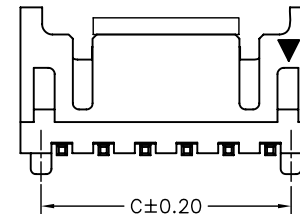

04P~20P

SPECIFICATIONS

Current Rating: 2A AC,DC
 Voltage Rating: 250V AC,DC
 Temperature Range: -25°C ~ +85°C
 Contact Resistance: 30mΩ Max.
 Insulation Resistance: 1000MΩ Min.
 Withstanding Voltage: 800V AC/minute
 Pin Material: Brass
 Cap: Nylon 6T,UL94V-0,Natural(Beige)

Circuit No.	Dimensions			
	A	B	C	D
2X02P	2.00	6.00	4.00	4.70
2X03P	4.00	8.00	6.00	6.70
2X04P	6.00	10.00	8.00	8.70
2X05P	8.00	12.00	10.00	10.70
2X06P	10.00	14.00	12.00	12.70
2X07P	12.00	16.00	14.00	14.70
2X08P	14.00	18.00	16.00	16.70
2X09P	16.00	20.00	18.00	18.70
2X10P	18.00	22.00	20.00	20.70
2X11P	20.00	24.00	22.00	22.70
2X12P	22.00	26.00	24.00	24.70
2X13P	24.00	28.00	26.00	26.70
2X14P	26.00	30.00	28.00	28.70
2X15P	28.00	32.00	30.00	30.70
2X16P	30.00	34.00	32.00	32.70
2X17P	32.00	36.00	34.00	34.70
2X18P	34.00	38.00	36.00	36.70
2X19P	36.00	40.00	38.00	38.70
2X20P	38.00	42.00	40.00	40.70

RoHS Compliant

TOLERANCES ARE

MORETHANALL
 PCB CONNECTORS
 Cable ASSEMBLIES

煜倫股份有限公司

www.morethanall.com

DRAWING BY CY

CHECKED BY GENIUS

UNIT / mm

SCALE 1 : 1

DATE

SIZE A4

X, ±
 .X ± 0.25
 .XX ± 0.15
 .XXX ± 0.05
 ANG ±

PJECTION

照片框

ORDER INFORMATION

DF11-VPCR-2Xxx-LF
 SERIES | | | LEADFREE
 | | | 2X02:04WAY
 | | | 2X20:40WAY
 180°SMT | REEL
 | CAP
 | POST

DESCRIPTION: 2.00mm PITCH 180° WAFER-SMT TYPE

2X02~2X06 Contacts

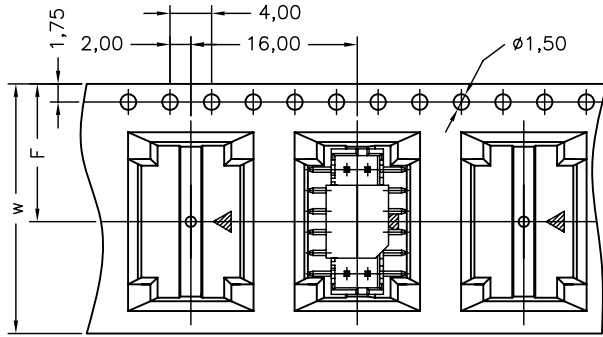

Unreeling direction →

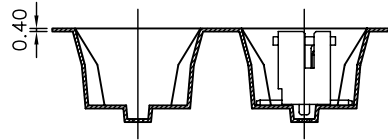

2X07~2X20 Contacts

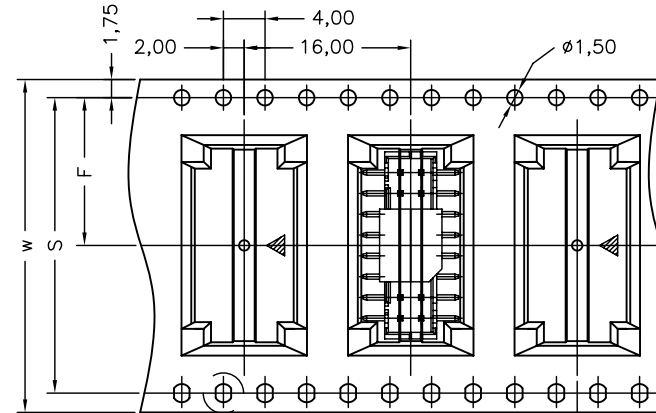

Unreeling direction →

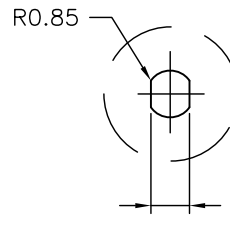

Number of Contacts	W±0.3	F±0.1	S±0.1	Q'ty/Reel
2X02P	16	7.50	/	400
2X03P	24	11.50		400
2X04P	24	11.50		400
2X05P	24	11.50		400
2X06P	24	11.50		400
2X07P	32	14.20		28.40
2X08P	32	14.20	28.40	400
2X09P	32	14.20	28.40	400
2X10P	44	20.20	40.40	400
2X11P	44	20.20	40.40	400
2X12P	44	20.20	40.40	400
2X13P	44	20.20	40.40	400
2X14P	44	20.20	40.40	400
2X15P	56	26.20	52.40	400
2X16P	56	26.20	52.40	400
2X17P	56	26.20	52.40	400
2X18P	56	26.20	52.40	400
2X19P	56	26.20	52.40	400
2X20P	56	26.20	52.40	400

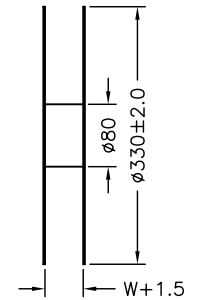
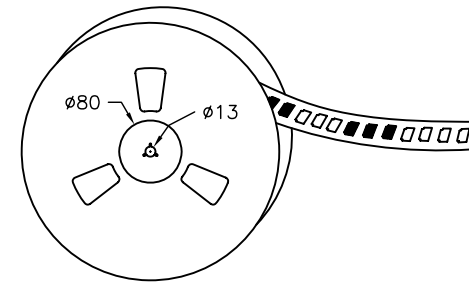
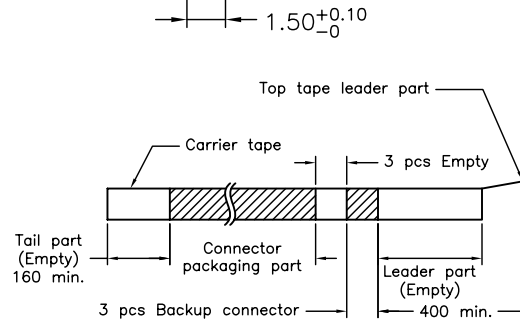

RoHS Compliant

TOLERANCES ARE

MORETHANALL
PCB CONNECTORS
Cable ASSEMBLIES

DRAWING BY CY

CHECKED BY GENIUS

UNIT / mm SCALE 1 : 1

DATE

SIZE A4

X, ±
.X ± 0.25
.XX ± 0.15
.XXX ± 0.05
ANG ±

PJECTION

照片框

ORDER INFORMATION

DF11-VPCR-2Xxx-LF
SERIES | | | LEADFREE
2X02:04WAY
2X20:40WAY
180°SMT | REEL
CAP
POST

DESCRIPTION: 2.00mm PITCH 180° WAFER-SMT TYPE

煜倫股份有限公司

www.morethanall.com