

T:1.6 Dimensions of PC board holes
Tolerance : ±0.05(Printed-top view)

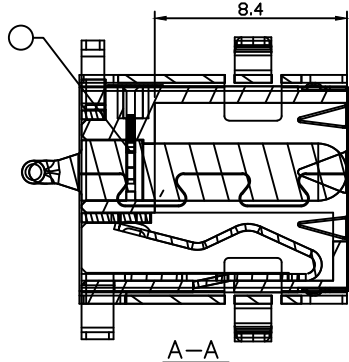

UNLESS OTHERWISE SPECIFIED, TOLERANCE ON DECIMAL:±0.3

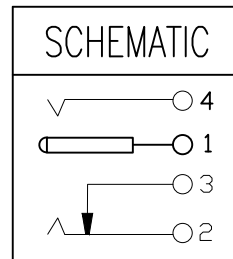

7	FLAT PIECE	1	SUS301	
6	HOUSING	1	PA9T	UL-94V0(BLACK)
5	SHIELD	1	SUS301	t=0.10
4	CONTACT FOOT	1	C2680	t=0.35 Ni PLATED
3	CURVE PIECE	1	C2680	t=0.40 Ag PLATED
2	SPRING PIECE	1	C5191	t=0.30 Ag PLATED
1	PIN	1	H59(COPPER ALLOY)	Ni PLATED
LTR	PART NAME	QTY	MATERIAL	REMARK

RoHS Compliant

TOLERANCES ARE

MORETHANALL
PCB CONNECTORS
Cable ASSEMBLIES

煜倫股份有限公司

www.morethanall.com

DRAWING BY CY

CHECKED BY GENIUS

UNIT / mm SCALE 1 : 1

DATE

SIZE A4

X. ±
.X ±
.XX ±
.XXX ±
ANG ±

P PROJECTION

照片框

ORDER INFORMATION

DCJ-RFR-25-LF
SERIES | | | LEADFREE
| | | 2.5Ø
| REEL
| OFFSET
| DIP 90°

DESCRIPTION: DC POWER JACK

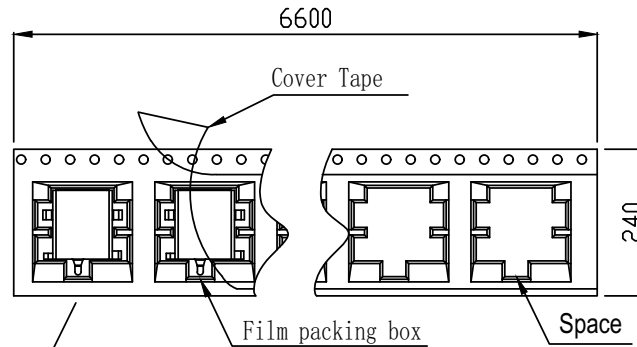
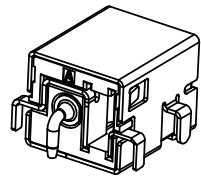

300pcs X 1 = 300pcs

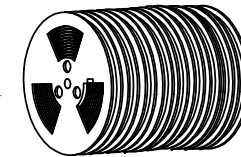
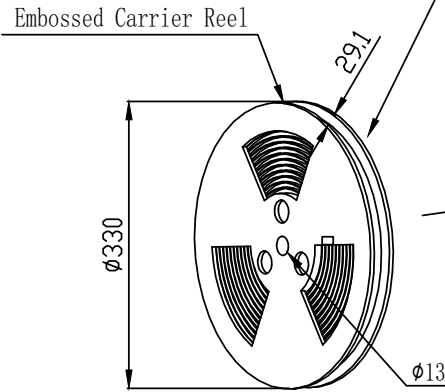

300pcs X 13 = 3900pcs

Unit:mm
Packing temperature request:
160°C~180°C

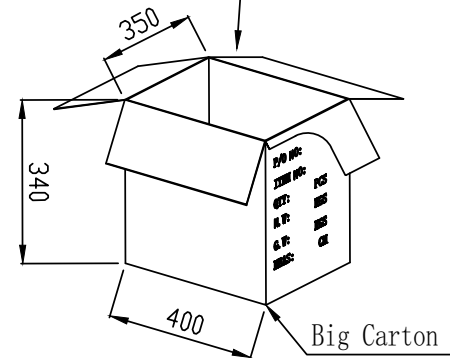

3900pcs X 1 = 3900pcs

Net weight:11Kg
Total weight:13.5Kg

RoHS Compliant

TOLERANCES ARE

MORETHANALL
PCB CONNECTORS
Cable ASSEMBLIES

煜倫股份有限公司

www.morethanall.com

DRAWING BY CY

CHECKED BY GENIUS

UNIT/mm SCALE 1:1

DATE

SIZE A4

X, ±
.X ±
.XX ±
.XXX ±
ANG ±

PJECTION

照片框

ORDER INFORMATION

DCJ-RFR-25-LF
SERIES | | | LEADFREE
| | | 2.5Ø
| REEL
| OFFSET
| DIP 90°

DESCRIPTION: