

LOCK WASHER

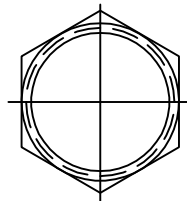

1/2-28 NUT

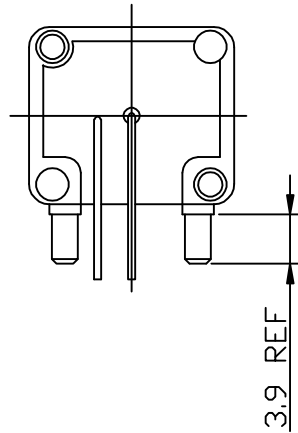

3.9 REF

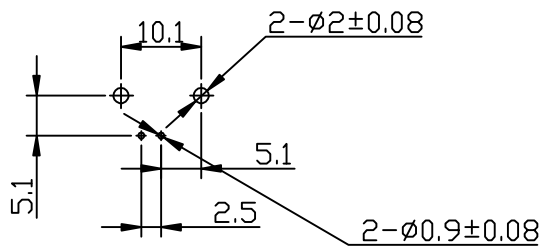
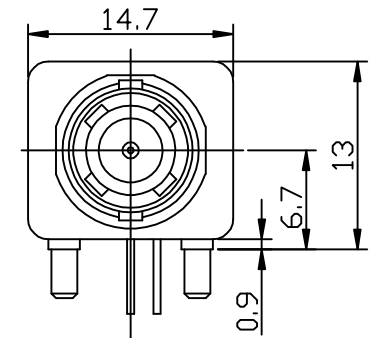
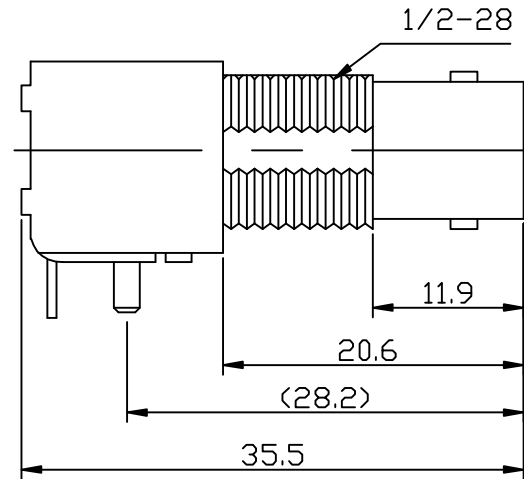
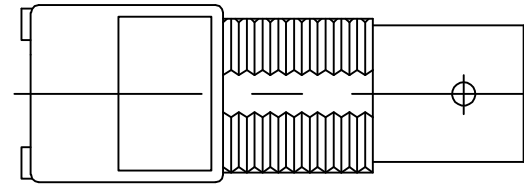

PCB HOLE CONFIGURATION
RECOMMENDED PANEL CUTOUTS

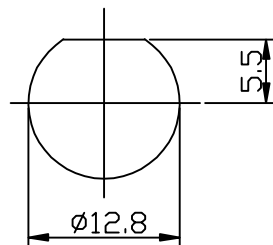

7	NUT	BRASS	NICKEL	1
6	WASHER	IRON	NICKEL	1
5	PIN	BRASS	TIN	1
4	PIN	BRASS	TIN	1
3	INSULATOR	PDM	NONE	1
2	BODY	ZINC ALLOY	NICKEL	1
1	CENTER CONTACT	PHOSPHOR BRONZE	GOLD	1
NO	DESCRIPTION	MATERIAL	FINISH	QTY

RoHS Compliant

TOLERANCES ARE

MORETHANALL
PCB CONNECTORS
Cable ASSEMBLIES

煜倫股份有限公司

www.morethanall.com

DRAWING BY CY

CHECKED BY GENIUS

UNIT / mm

SCALE 1:1

DATE

SIZE A4

P PROJECTION

0.5-5	=±0.2
6-30	=±0.4
30-120	=±0.6
120-315	=±1
315-1000	=±1.6
1000-2000	=±2.4



照片框

ORDER INFORMATION

BNC-JR13WFM-50-LF
SERIES | | | LEADFREE
JACK | | | 50 OHM
DIP 90° | | | FULL METAL
NUT+WASHER
HIGH 13.1mm

DESCRIPTION: 50Ω BNC R/A PCB/PANEL MOUNT JACK, METAL BODY